



Catalogue petit outillage

Pinces, tournevis, péniches, etc.

Tel : +33 6 19 58 54 61 - Fax : +33 2 32 50 22 93

Eim Optique Services – 5, rue des Drapiers
27110 Venon

www.eim-optique-services.com
contact@eim-optique-services.com

Sommaire

	N° Pages		N° Pages
•Accessoires lentilles de contact	3 à 4	•Lunettes de maquillage	47
•Accessoires de lunetterie	5 à 9	•Mallettes d'outillage	48
•Appareils de tests	10 à 11	•Marteaux – Pointeaux.....	49
•Appuis - Bigornes	12	•Meulettes	50
•Audioprothèses	13	•Montage rimless	51
•Branches	14 à 17	•Occlusions – Obturateurs – Press on....	52
•Brossettes et polissoirs	18	•Péniches et boîtiers de rangements.....	53 à 54
•Brucelles	19	•Perceuses	55 à 57
•Cavaliers plastique	20	•Petites fournitures	58 à 62
•Clés	21 à 22	•Pincés	63 à 78
•Colles.....	23	•Plaquettes	79 à 85
•Coloration	24 à 26	•Polissage	86 à 87
•Embouts - Gaines	27 à 30	•Pointe à tracer et feutres.....	88
•Embouts presse verre souple BRIOT....	31	•Potences à river	89 à 90
•Équarisseurs - Scies	32	•Râteliers	91
•Étaux	33	•Retouches	92
•Examens de vue	34 à 36	•Roule goupilles - Grattoirs.....	93
•Forêts	37	•Soudage	94 à 95
•Fraises	38	•Tarauds	96
•Glands -Blocs.....	39	•Tensiscopes	97
•Instruments de mesure.....	40 à 42	•Tournevis	98 à 104
•Limes	43 à 45	•Ultrasons	105
•Loupes	46	•Ventilettes.....	106
		•Visserie	107 à 115
		• Nouveaux produits	116 à 120

Équipements et accessoires pour lentilles de contact

Equipments and accessories for contact lenses



ET-905/12

ÉTUIS double décor
(Assortiment de 12 pièces)
DOUBLE CASES with decoration
(12 assorted pieces)



CO-905/24

TUBES pour lentilles de contact
(Assortiment de 24 pièces décor)
VIALS for contact lenses
(24 assorted pieces with decoration)

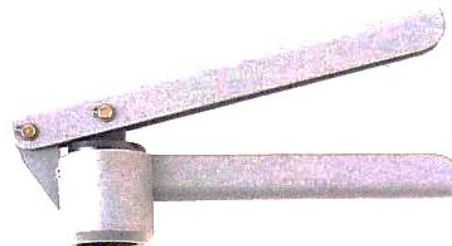

PI-550 PINCE A CAPSULER
CAP CRIMPING TOOL



- 1 BR-309** BRUCELLES EN PLASTIQUE avec pointes silicone
Petit modèle (Sachet de 12 pcs)
PLASTIC TWEEZERS with silicone points
Small type (Bag of 12 pcs)
- 2 BR-310** BRUCELLES EN PLASTIQUE avec pointes silicone
Grand modèle (1 pc)
PLASTIC TWEEZERS with silicone points
Large type (1 pc)

Équipements et accessoires pour lentilles de contact

Equipments and accessories for contact lenses



CO-899 COFFRET CONTACT avec miroir contenant 1 étui double pour lentilles et 1 paire de brucelles plastique petit modèle et 2 tubes
Boîte de 5 coffrets couleurs assorties
CONTACT BOX with mirror. Containing 1 contact lens case and plastic tweezers (small type) and 2 tubes
Box of 5 pieces, assorted colours



CO-920 COUPELLE DOUBLE pour préparation des lentilles (1 pc)
Contact lens DISPENSING TRAY (1 pc)



CO-901/12 TUBE DOUBLE pour lentilles de contact (12 pièces, couleurs assorties)
VIAL for contact lenses
(12 pieces, assorted colours)



ET-901/12
ÉTUI DOUBLE
(12 pièces, couleurs assorties)
DOUBLE CASE
(12 pieces, assorted colours)



BO-150
FLACON POUR LENTILLES
(Paquet de 24 pcs)
CONTACT LENS GLASS VIAL
(Pack of 24 pcs)



DE-100
DÉCAPSULEUR pour flacons de lentilles équipés de capsules type BO-153
OPENER for contact lens vial equipped with crimping caps like BO-153



1 VE-200
VENTOUSE pour poser et déposer les lentilles dures (Boîte de 12 pcs)
HARD CONTACT LENS REMOVER
(Box of 12 pcs)



BO-151
BOUCHON PLASTIQUE
(Paquet de 24 pcs)
PRESEAL (Pack of 24 pcs)



BO-153 CAPSULES couleurs assorties (Paquet de 100 pcs)
CRIMPING CAPS assorted colours (Pack of 100 pcs)

2 VE-201
VENTOUSE avec effet aspirant, pour lentilles de contact souples (Boîte de 12 pcs)
SUCTION CUP with suction effect, for soft contact lenses (Box of 12 pcs)



BO-152
BOUCHON EN SILICONE
(Paquet de 24 pcs)
SILICONE STOPPER (Pack of 24 pcs)

Accessoires de la lunetterie

Eyewear accessories



HI-210 BANDE SPORT élastique noire (Boîte de 12 pcs)
Black elastic SPORT BAND (Box of 12 pcs)



CO-300 COUSSINETS DE NEZ. Rose. 12 sachets de 4 paires
CUSHION-REST NOSE PADS. Pink. 12 bags of 4 pairs

SUREMBOUTS EN SILICONE
Long. = 67 mm (12 sachets de 1 paire)
SLIP STOP TEMPLE TIPS
Length = 67 mm (12 bags of 1 pair)

HI-100 Petit - Ø int. = 3 x 2
Small - Inner Ø = 3 x 2

HI-101 Moyen - Ø int. = 3,5 x 3
Medium - Inner Ø = 3,5 x 3

HI-102 Grand - Ø int. = 4 x 3
Large - Inner Ø = 4 x 3

HI-103 Câble - Ø int. = 3
Cable - Inner Ø = 3

Coques de bronzage

Tanning goggles

CO-352/10

COQUES DE BRONZAGE
couleurs assorties (10 pièces)
TANNING GOGGLES
assorted colours (10 pieces)

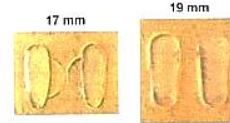

PLAQUETTES DE NEZ en silicone autocollantes (Sachet de 5 paires)
Stick-on silicone NOSE PADS (Bag of 5 pairs)

PL-190/5 17 mm

PL-191/5 19 mm



CROCHET de sécurité en silicone (boîte de 12 paires)
Silicone frame LOCK (box of 12 pairs)

CR-149 Assort. / Set

CR-150 Brun / Brown

CR-151 Cristal / Crystal

CR-152 Noir / Black



CROCHET de sécurité en silicone avec blocage (boîte de 12 paires)
Silicone frame LOCK with blocking part (box of 12 pairs)

CR-155 Noir / Black

CR-156 Vert / Green

CR-157 Rose / Pink



TISSUS DE NETTOYAGE en microfibre ourlés, livrés en étuis vinyl individuels et en boîte présentoir de 12 pièces
LENS CLEANING CLOTHS in microfiber - Neat finished edge - Supplied in vinyl case and 12 pieces display box

1 CH-409 Assort. - Teintes unies / Set - Plain colour (180 x 150 mm)

2 CH-419 Assort. - Motif cachemire / Set Paisley pattern (180 x 130 mm)



SPRAY NETTOYANT
SPRAY LENS CLEANER
NE-120 12 pièces en boîte présentoir
12 pieces in display box

Accessoires de la lunetterie

Eyewear accessories



Faces avec crochets centraux (UV 400)

Slip-on with central hooks (UV 400)

Face polarisée avec crochets centraux extra longs, munis de gaines de protection évitant les rayures (L x h = 62 x 54 mm)
 Metal slip-on, polarized, with extra long protective tips to ensure scratch free application. (L x h = 62 x 54 mm)



FA-100 Gris / Grey (1 pc)

FA-101 Marron / Brown (1 pc)

FA-100/1 Gainses de protection de rechange pour crochets (sachet de 10 pcs)
 Replacement protective tips for hooks (bag of 10 pcs)

Solar shields

Solar shields (UV 380)



SO-302
 Gris bleuté / Grey-blue

Surlunettes de protection solaire

Over the glasses sun protection (UV 400)

SO-305 Fumé / Smoke



SO-306 Ambre / Amber



SURLUNETTE
 pour monture n'excedant pas 138 x 50 mm,
 Excellente protection solaire,
 100 % UV protection - Légère,
 verres et monture en polycarbonate
 Fits over Rx frames not exceeding 138 x 50 mm
 Excellent sun light protection
 100 % UV protection
 Lenses and frame in polycarbonate

Lunettes de protection

Protective goggles



1 LU-233 LUNETTES DE PROTECTION "SOUDEUR" indice 7
 "SOLDERER" PROTECTIVE GOGGLES index 7

2 LU-230 LUNETTES DE PROTECTION EN POLYCARBONATE CRISTAL
 CRYSTAL POLYCARBONATE PROTECTIVE GOGGLES

3 LU-231 LUNETTES DE PROTECTION "SURF"
 PROTECTIVE GOGGLES "SURF"



FA-230 FACES RELEVABLES DE PROTECTION DES
 VERRES CORRECTEURS - CRISTAL
 SPRING CLIP FLIP-UP FOR THE PROTECTION OF
 CORRECTIVE LENSES - CRYSTAL

Faces supplémentaires

Clips flip-up

Brun = classe 2 - Gris = classe 3 / Brown = class 2 - Grey = class 3

Protection UV.A / UV.B
UVA / UVB Protection

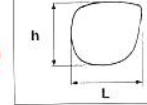

Faces relevables avec mécanisme métal. Facilement applicables d'une seule main

Spring clips flip-up with metal mechanism. Easy one hand application

Brun = classe 2 - Gris = classe 3 / Brown = class 2 - Grey = class 3

Forme droite, découpable / Straight form, cut to fit (L x h = 62 x 54 mm)

FA-110 Polarisée, gris / Polarized, grey (1 pc)

FA-111 Polarisée, marron / Polarized, brown (1 pc)



Forme arrondie, découpable
Rounded form, cut to fit (L x h = 62 x 54 mm)

FA-120 Polarisée, gris / Polarized, grey (1 pc)

FA-121 Polarisée, marron / Polarized, brown (1 pc)



Forme carrée, découpable (L x h = 61 x 54 mm)
Square form, cut to fit (L x h = 61 x 54 mm)

FA-140 Polarisée, gris / Polarized, grey (1 pc)

FA-141 Polarisée, marron / Polarized, brown (1 pc)



Faces relevables avec mécanisme plastique. Facilement applicables d'une seule main

Spring clips flip-up with plastic mechanism. Easy one hand application

Forme droite, grand modèle, découpable (L x h = 68 x 57 mm)
Straight form, large size, cut to fit (L x h = 68 x 57 mm)

FA-118/12 Polarisée, gris / Polarized, grey (12 pcs)

FA-119/12 Polarisée, marron / Polarized, brown (12 pcs)



Forme droite / Straight form (L x h = 62 x 54 mm)

FA-112/12 Polarisée, découpable, gris (12 pcs)
Polarized, cut to fit, grey (12 pcs)

FA-113/12 Polarisée, découpable, marron (12 pcs)
Polarized, cut to fit, brown (12 pcs)

FA-212/12 Non polarisée, gris, non découpable (12 pcs)
Non polarized, grey, cannot be cut (12 pcs)

FA-213/12 Non polarisée, marron, non découpable (12 pcs)
Non polarized, brown, cannot be cut (12 pcs)



Forme droite, taille moyenne, découpable (L x h = 57 x 47 mm)
Straight form, medium size, cut to fit (L x h = 57 x 47 mm)

FA-116/12 Polarisée, gris / Polarized, grey (12 pcs)

FA-117/12 Polarisée, marron / Polarized, brown (12 pcs)



Forme droite, petite taille, découpable (L x h = 46 x 40 mm)
Straight form, small size, cut to fit (L x h = 46 x 40 mm)

FA-114/12 Polarisée, gris / Polarized, grey (12 pcs)

FA-115/12 Polarisée, marron / Polarized, brown (12 pcs)



Forme droite / Straight form (L x h = 62 x 54 mm)

FA-125 Non polarisée, jaune, non découpable (1 pc)
Non polarized, yellow, cannot be cut (1 pc)

FA-127 Polarisée, jaune, découpable (1 pc)
Polarized, yellow, cut to fit (1 pc)



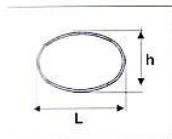

Clips et faces instantanées

Clips and instant sunglasses

Clips / Clips

Protection UVA / UVB
UVA / UVB Protection

CLIPS RECTANGULAIRES.
Cérclage gris. Barre de liaison à ressort.
RECTANGULAR CLIPS.
Grey hoopsing. Spring bar.



Taille / Size mm		Non polarisés / Non polarized	
L	h	Verres bruns Brown lenses	Verres gris Grey lenses
46	32	CL-320/46	CL-322/46
48	34	CL-320/48	CL-322/48
50	36	CL-320/50	CL-322/50
52	38	CL-320/52	CL-322/52



Taille / Size mm		Polarisés / Polarized	
L	h	Verres bruns Brown lenses	Verres gris Grey lenses
46	32	CL-321/46	CL-323/46
48	34	CL-321/48	CL-323/48
50	36	CL-321/50	CL-323/50
52	38	CL-321/52	CL-323/52



Faces instantanées

Instant sunglasses

Les faces instantanées se posent et s'enlèvent facilement d'une main.
Elles assurent une protection latérale partielle. Livrées en boîte
de 12 pièces.
Instant sunglasses can be easily settled and removed with one hand only.
They assure a partial lateral protection. Delivered in box of 12 pieces.



HI-250 Gris. Taille standard. Non polarisée /
Grey. Standard size. Non polarized

HI-251 Gris. Taille standard. Polarisée /
Grey. Standard size. Polarized

HI-252 Gris. Grande taille. Polarisée /
Grey. Large size. Polarized



HI-260 Jaune. Taille standard /
Yellow. Standard size

Verres CR 39

CR 39 lenses

Diamètre 71 mm, épaisseur 1,8 mm.
Base 6, UV 400, 3 paires
Diameter 71 mm, thickness 1.8 mm.
Base 6, UV 400, 3 pairs

VE-300/3

Cristal / Crystal
UV 380



VE-301/3

Brun / Brown



VE-302/3

Gris / Grey



VE-303/3

Vert / Green



VE-306/3

Brun foncé / Dark brown
Classe 4 / Category 4



VE-307/3

Gris foncé / Dark grey
Classe 4 / Category 4



VE-308/3

Vert foncé / Dark green
Classe 4 / Category 4



VE-320/3

Jaune / Yellow

SP-300

PRODUIT DE PROTECTION
DES VERRES ET ANTI-GLISSE

À vaporiser sur les verres avant façonnage.
Peut être nettoyé avec de l'eau ou de l'alcool.
ANTI-SLIP AND PROTECTIVE
PRODUCT FOR LENSES
To spray on lenses before shaping.
Can be cleaned with water or methylated spirits.



EN-300/C

ENVELOPPE pour 1 paire de verres.
Intérieur avec triple protection
(paquet de 100 pièces)
WRAPPER for 1 pair of lenses.
Inside with triple protection
(pack of 100 pieces)

ST-800

STYLOS POUR LA COLORATION DU BORD DES VERRES.

Assortiment de 8 stylos = 7 teintes + 1 correcteur

PENS FOR COLOURING THE EDGE OF LENSES. Set of 8 pens = 7 colours + 1 corrector

Teintes de l'assortiment ST-800
Colours of the ST-800 set

- ST-004 : noir brillant / bright black
- ST-315 : ocre / ochre
- ST-326 : cognac / cognac
- ST-328 : fuchsia / bright pink
- ST-332 : vert foncé / dark green
- ST-333 : bordeaux / burgundy
- ST-341 : turquoise / turquoise blue
- ST-799 : correcteur / corrector



ST-810

Assortiment de 7 verres bords colorés avec les teintes de l'assortiment ST-800
Set of 7 lenses with edges coloured with the tints of the ST-800 set



Appareils divers

Small machines

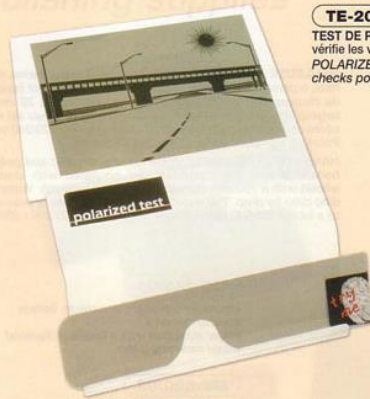

TE-200

TEST DE POLARISATION
vérifie les verres polarisés
POLARIZED TEST
checks polarized lenses

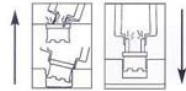
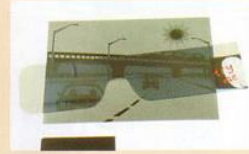

AP-299

APPAREIL POUR REMPLACER
LES CHARNIÈRES INCRUSTÉES
Commande à pédale, 220/240 volts, poids 2,2 kg.
Dim. : 160 x 130 x 110 mm

MACHINE FOR REPLACEMENT OF HIDDEN HINGES
With foot control switch, 220/240 volts, weight 2.2 kg.
Size : 160 x 130 x 110 mm

AP-299/12

ÉQUERRES DE RECHANGE
(1 paire)
REPLACEMENT CONTACT POINTS
(1 pair)



AP-460

APPAREIL POUR TESTER LES VERRS PHOTOCROMIQUES
220/240 volts - Poids : 1,75 kg - Dimensions : 120 x 220 x 125 mm
PHOTOCHROMIC LENS TESTING MACHINE
220/240 volts - Weight : 1.75 kg - Size : 120 x 220 x 125 mm



Appareils divers

Small machines



AP-445

APPAREIL POUR TESTER LA VISION DE PRÈS.

Permet d'effectuer une vérification complète de la vision réfractive et binoculaire. Les échelles peuvent être allumées individuellement soit par une commande sur l'appareil, soit par une télécommande infrarouge. Livré avec un filtre polarisé.

NEAR VISION TESTER.

Allows to carry out a complete check-up of the refractive and binocular vision. Charts can be illuminated individually either by means of a control on the tester or of an infra red remote control. Delivered with a polarized filter.



LA-103

MINI LAMPE À PINCE "HIBOU".

Se monte sur toutes les lunettes (pour la lecture, les travaux de précision, le voyage...).

MINI CLAMPING LAMP "OWL".

Can be mounted on all spectacles (for reading, precise labours, travelling...).

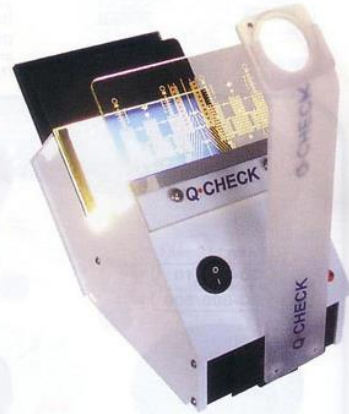

AP-447

APPAREIL MULTI-CONTRÔLE.

Permet :

- la vérification du centrage,
- la reconnaissance des parafes et marquages sur les verres progressifs,
- la vérification des tensions,
- la vérification de la surface (défauts).

MULTITEST DEVICE.

Allows :

- to check the centring,
- to identify initials and markings on progressive lenses,
- to check strains
- to check the surface (defaults).



LA-103/1

PILE DE RECHANGE POUR LA-103.

(CR-1/3 N - 3 V). 40 heures.

REPLACEMENT BATTERY FOR LA-103.

(CR-1/3 N - 3 V). 40 hours.



PU-192

MINI PUPILLOMÈTRE DIGITAL.

Permet de mesurer la distance pupillaire. Pile de 12 volts. Dimensions : 200 x 100 x 40 mm. Poids : 0,2 kg.



MINI DIGITAL PUPILLOMETER.

Allows to measure pupillary distance. Battery : 12 volts. Size = 200 x 100 x 40 mm. Weight : 0,2 kg.

Appuis - Bigornes

Bench blocks - Anvils



TR-151

TROISIÈME MAIN (appui)
Avec 1 lame plate, 1 lame cruciforme et 3 clés pour écrou
THIRD HAND (support)
With 1 flat blade, 1 cross blade and 3 nut wrenches

TR-151/1

Lames de rechange pour TR-151 - Assortiment de 5 x 1 pièce
Replacement blades for TR-151 - Set of 5 x 1 pc

TO-112/6

Lame plate Ø 1,8
Flat blade Ø 1.8 (1 pc)

TO-113/6

Lame cruciforme Ø 2,0
Cross blade Ø 2.0 (1 pc)

CL-102/B0

Clé pour écrou étoile de 2,2
Blade for star nut 2.2 (1 pc)

CL-102/B7

Clé pour écrou hexagonal de 2,5
Blade for hexagonal nut 2.5 (1 pc)

CL-102/B4

Clé pour écrou étoile de 2,5
Blade for star nut 2.5 (1 pc)

TR-150

TROISIÈME MAIN (appui) (non illustré)
Même appui que TO-151 mais avec 3 lames (1 lame plate, 1 lame cruciforme et 1 clé pour écrou)
THIRD HAND (support) (without picture)
Same support as TO-151 but with 3 blades (1 flat blade, 1 cross blade and 1 nut wrench)



AP-505

APPUI AVEC REHAUSSE
Massif et très résistant.
Tête munie d'une cale en bois dur
SUPPORT WITH RAISING MASSIVE
AND VERY RESISTANT HEAD
fitted with a block in hard wood

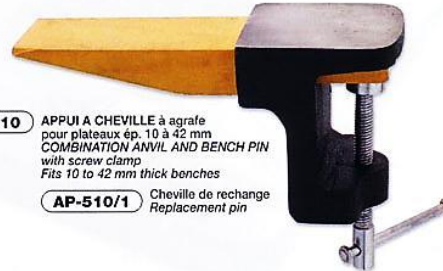

AP-510

APPUI A CHEVILLE à agrafe
pour plateaux ép. 10 à 42 mm
COMBINATION ANVIL AND BENCH PIN
with screw clamp
Fits 10 to 42 mm thick benches

AP-510/1

Cheville de rechange
Replacement pin



EN-200

ENCLUME D'OPTICIEN
avec pointe interchangeable
OPTICIAN ANVIL
with interchangeable
pointed punch

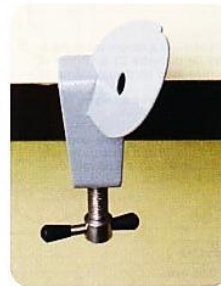

ME-300

MENTONNET - Appui à agrafe
pour plateaux ép. 10 à 46 mm. Acier laqué
SUPPORT with screw clamp
Fits 10 to 46 mm thick benches
Painted steel



AP-500

APPUI CAGOUTCHOUX
RUBBER COVERED
BENCH BLOCK



EN-220

ENCLUME - Acier nickelé - Largeur 110 mm
Poids : 460 g
HORN ANVIL - Nickel plated steel
110 mm wide - Weight : 460 g



BI-100

BIGORNE sur socle fonte
HORN ANVIL on cast iron base

Piles pour appareils auditifs
Hearing aid batteries



- PI-480/010** Piles (pack 10 blisters) / Batteries (batch of 10 blister packs) n° 10
- PI-480/013** Piles (pack 10 blisters) / Batteries (batch of 10 blister packs) n° 13
- PI-480/312** Piles (pack 10 blisters) / Batteries (batch of 10 blister packs) n° 312
- PI-480/675** Piles (pack 10 blisters) / Batteries (batch of 10 blister packs) n° 675



- PI-480/700** Support + 4 x 10 blisters
Display + 4 x 10 blister packs
- PI-480/001** Support blisters
Display of blister packs

Bouchons d'oreilles
Ear plugs



- BO-600 3M**
- BOÎTE DE 200 PAIRES DE BOUCHONS en polyuréthane doux hypoallergénique.
Normes : EN 352-2.
SNR* : 31 db
- BOX OF 200 PAIRS OF EAR PLUGS in soft hypoallergenic polyurethane.
Standard : EN-352-2.
SNR* : 31 db



- BO-605 EAR**
- BOÎTE DE 200 PAIRES DE BOUCHONS YELLOW avec cordelette, en mousse de polyuréthane, conditionnés en sachets individuels, taille unique.
Normes : EN 352-2.
SNR* : 36 db
- BOX OF 200 PAIRS OF YELLOW EAR PLUGS with cord, in polyurethane foam, packed in individual bags, one size.
Standard : EN-352-2.
SNR* : 36 db



- BO-610 EAR**
- BOUCHONS MONTÉS SUR ARCEAU en mousse de polyuréthane, taille unique. Conditionnement en pillow pack, 1 paire.
Normes : EN 352-2.
SNR* : 23 db
- BANDED EAR PLUGS in polyurethane foam, one size. Packed in pillow pack, 1 pair.
Standard : EN-352-2
SNR* : 23 db

- BO-610/1**
- LA PAIRE DE BOUCHONS DE RECHANGE
PAIR OF REPLACEMENT PLUGS

*SNR : rapport signal sur bruit / signal-to-noise ratio

Branches

Temples

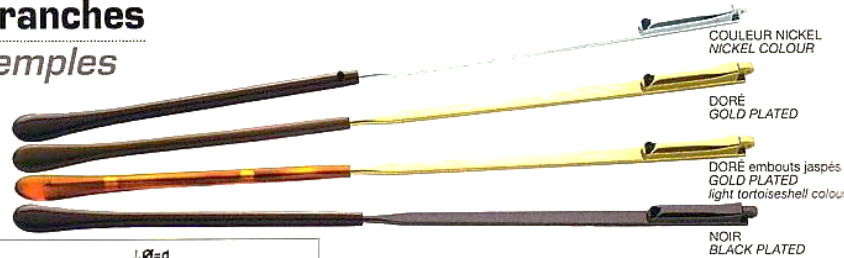

COULEUR NICKEL
NICKEL COLOUR

DORÉ
GOLD PLATED

DORÉ embouts jaspés
GOLD PLATED
light tortoiseshell colour tips

NOIR
BLACK PLATED

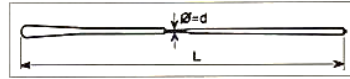

Sachets de 5 paires / Bags of 5 pairs

Branches en maillechort avec charnière télescopique - Embouts courts

Diamètre de tige [d] = 1,45 - Longueur [L] = 135 - Largeur de talon = 3,3

Nickel silver temples with spring hinges - Short tips

Shank diameter [d] = 1.45 - Length [L] = 135 - Heel width = 3.3

Teintes / Colours		Assemblages / Assembly (largeur de charnière / hinge width)				
Branche Temple	Embout Tip					
		0,8	1,0	1,2	1,3	1,4
NICKEL NICKEL	NOIR BLACK	BR-128-08/5	BR-128-10/5	BR-128-12/5	BR-128-13/5	BR-128-14/5
OR GOLD	BRUN BROWN	BR-138-08/5	BR-138-10/5	BR-138-12/5	BR-138-13/5	BR-138-14/5
OR GOLD	JASPE LIGHT TORT.	BR-138-08/E5	BR-138-10/E5	BR-138-12/E5	BR-138-13/E5	BR-138-14/E5
NOIR BLACK	NOIR BLACK	BR-148-08/5	BR-148-10/5	BR-148-12/5	BR-148-13/5	BR-148-14/5
GUN GUN	NOIR BLACK	BR-149-08/5	BR-149-10/5	BR-149-12/5	BR-149-13/5	BR-149-14/5

Branches en Beryllium avec charnière télescopique - Embouts courts ultra-légers

Diamètre de tige [d] = 1,0 - Longueur [L] = 140 - Largeur de talon = 2,4

Beryllium temples with spring hinges - Short ultra light tips

Shank diameter [d] = 1.0 - Length [L] = 140 - Heel width = 2.4



BR-167/5 COULEUR NICKEL / NICKEL COLOUR

BR-177/5 DORÉ / GOLD PLATED

BR-177/E5 DORÉ embouts jaspés / GOLD PLATED light tortoiseshell colour tips

BR-187/5 NOIR / BLACK PLATED

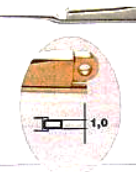

Montage branches Flex

Mounting of Flex temples

AP-520

Dispositif de montage complet des branches Flex

Device for the complete mounting of Flex temples

L'appareil se prête au montage de la plupart des branches Flex. Il permet l'utilisation de vis standard de diamètre de tête 1,8 à 2,0 ou 2,5 mm, fendues ou cruciformes. Le dispositif est livré avec 2 types de guidage des vis et 2 tournevis à lame longue (un avec une lame plate et l'autre avec une lame cruciforme).

The device lends itself to the mounting of most Flex temples. It allows the use of standard slotted or cross screws with a 1.8 to 2.0 or 2.5 mm head diameter. This device is delivered with two screw guiding types and two screwdrivers with long blades (one with a flat blade and the other one with a cross blade).

KIT DE MONTAGE COMPRENANT :

MOUNTING DEVICE INCLUDING :

- 1 Appareil / Device
- 1 Tournevis lame plate extra longue (2,0) / Screwdriver with extra long flat blade (2.0) **(TO-180/A20)**
- 1 Tournevis lame cruciforme extra longue (2,0) / Screwdriver with extra long cross blade (2.0) **(TO-181/A20)**
- 1 Porte-aiguille / Needle support **(AP-520/06)**
- 1 Guide vis, têtes Ø 1,8 à 2,0 mm / Guide for screws with a 1.8 to 2.0 mm head diameter **(AP-520/051)**
- 1 Guide vis, têtes Ø 2,5 mm / Guide for screws with a 2.5 mm head diameter **(AP-520/061)**

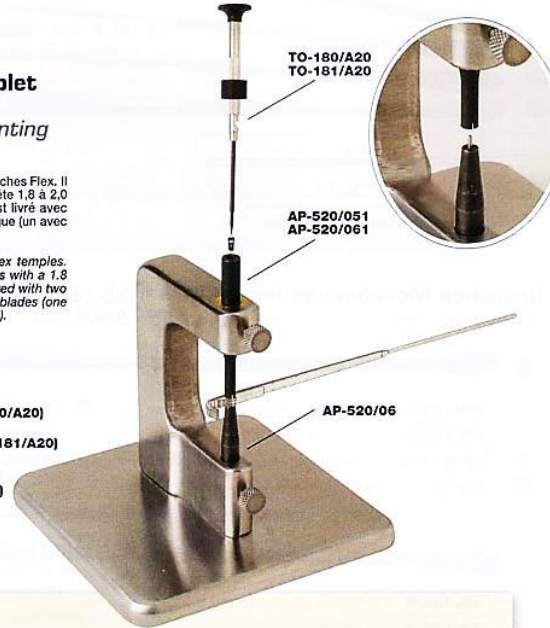

PI-208/B

PINCE À MONTER LES BRANCHES FLEX

Ce kit permet d'ouvrir la branche Flex et ensuite de la bloquer dans cette position pour permettre l'assemblage avec une vis standard.

Acier inoxydable - 165 mm - 70 g

FLEX TEMPLE MOUNTING PLIER

This kit enables to open the Flex temple and then to block it in this position to enable the assembly with a standard screw.

Stainless steel - 165 mm - 70 g

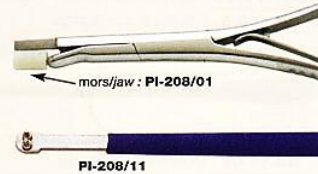

PI-208/01 Mors de rechange / Replacement jaw (1 pc)

PI-208/11 Extracteur seul / Extractor only



EN-150

ENSEMBLE POUR MONTAGE DES CHARNIÈRES FLEX

SET FOR THE MOUNTING OF FLEX HINGES

Trousse comprenant / Pouch including :

Pince/Plier (EN-152), Brucelle/Tweezer (EN-151), Extracteur/Extractor (EN-154), 3 Cales/Wedges (EN-153)

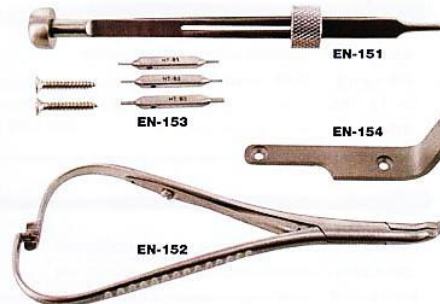

Branches

Temples

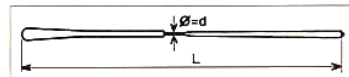

Sachets de 5 paires / Bags of 5 pairs

Branches Monobloc en bronze - d = 1,35 - Embouts courts

Monobloc temples in bronze - d = 1.35 - Short tips



- BR-120/5** COULEUR NICKEL / NICKEL COLOUR
- BR-130/5** DORÉ / GOLD PLATED
- BR-130/E5** DORÉ embouts jaspés / GOLD PLATED light tortoiseshell colour tips
- BR-140/5** NOIR / BLACK PLATED



- BR-160/5** COULEUR NICKEL / NICKEL COLOUR
- BR-170/5** DORÉ / GOLD PLATED
- BR-170/E5** DORÉ embouts jaspés / GOLD PLATED light tortoiseshell colour tips
- BR-180/5** NOIR / BLACK PLATED



- BR-161/5** COULEUR NICKEL / NICKEL COLOUR
- BR-171/5** DORÉ / GOLD PLATED
- BR-171/E5** DORÉ embouts jaspés / GOLD PLATED light tortoiseshell colour tips
- BR-181/5** NOIR / BLACK PLATED



- BR-121/5** COULEUR NICKEL / NICKEL COLOUR
- BR-131/5** DORÉ / GOLD PLATED
- BR-131/E5** DORÉ embouts jaspés / GOLD PLATED light tortoiseshell colour tips
- BR-141/5** NOIR / BLACK PLATED



- BR-122/5** COULEUR NICKEL / NICKEL COLOUR
- BR-132/5** DORÉ / GOLD PLATED
- BR-132/E5** DORÉ embouts jaspés / GOLD PLATED light tortoiseshell colour tips
- BR-142/5** NOIR / BLACK PLATED



Branches souples en Nibrodal - d = 1,0 - Embouts ultra-légers

Flexible temples in Nibrodal - d = 1.0 - Ultra light tips



Branches charnières en bronze - d = 1,35 - Embouts courts

Hinge temples in bronze - d = 1.35 - Short tips



Branches métalliques cordées équipées d'embouts en silicone

Metal curl temples with silicone temple tips

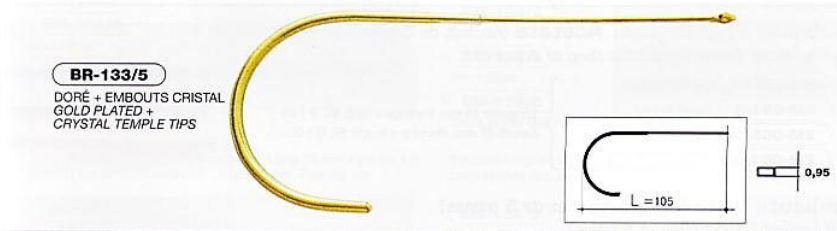

Branches plastique

Plastic temples



Branches en acétate (sachets de 3 paires)

Acetate temples (bags of 3 pairs)





Brossettes et polissoirs

Brushes and buffs

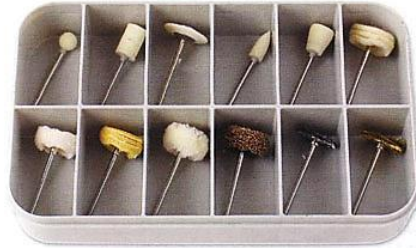

BR-102 ASSORTIMENT DE BROSSETTES ET POLISSOIRS comprenant :
SET OF BRUSHES AND POLISHERS including :

- 1 pc du BR-073 au BR-089 inclus (●)
- 1 pc from BR-073 to BR-089 included (●)



BR-100 ASSORTIMENT DE 24 BROSSETTES, MEULETTES ET POLISSOIRS sur support présentoir
SET OF 24 BRUSHES, SMALL WHEELS AND POLISHERS on display

BR-100/1 SUPPORT PRÉSENTOIR seul
DISPLAY only

Sachet de 2 pcs par référence / Bag of 2 pcs per model

- | | |
|--|--|
| <p>● BR-073 Sphérique
feutre dur Ø 8 mm
Spherical hard felt Ø 8 mm</p>  | <p>● BR-088 Disque chamois
Ø 22 mm
Chamois leather Ø 22 mm</p>  |
| <p>● BR-074 Brossette
feutre dur cyl. Ø 10 mm
Cylindrical hard felt Ø 10 mm</p>  | <p>● BR-089 Brossette
coton Ø 22 mm
Cotton buff Ø 22 mm</p>  |
| <p>● BR-076 Lentille
feutre dur Ø 21 mm
Knife edge hard felt Ø 21 mm</p>  | <p>● BR-075 Brossette scotch
Britt Ø 20 mm
Satin finish buff (scotch Britt) Ø 20 mm</p>  |
| <p>● BR-077 Cône
feutre dur Ø 6 mm
Pointed hard felt cone Ø 6 mm</p>  | <p>● BR-080 Brossette
fils acier Ø 22 mm
Steel brush Ø 22 mm</p>  |
| <p>● BR-085 Tronconique
feutre dur Ø 14 mm
Truncated hard felt Ø 14 mm</p>  | <p>● BR-081 Brossette
fils laiton Ø 22 mm
Brass brush Ø 22 mm</p>  |
| <p>● BR-086 Disque
feutre souple Ø 22 mm
Disc soft felt Ø 22 mm</p>  | |
| <p>● BR-079 Disque flanelle
Ø 22 mm
Flannel buff Ø 22 mm</p>  | |

Brucelles

Tweezers



BR-103 BRUCELLES à tenir les vis, becs courbés.
Acier inoxydable
Screw holding TWEEZERS, bent noses.
Stainless steel



BR-105 BRUCELLES à tenir les vis. Acier inoxydable
Screw holding TWEEZERS. Stainless steel



BR-106 BRUCELLES à tenir les vis (pointes étroites).
Acier inoxydable
Screw holding TWEEZERS (narrow points).
Stainless steel



BR-107 BRUCELLES auto-serrantes à tenir les vis.
Acier inoxydable
Self-closing screw holding TWEEZERS.
Stainless steel



BR-108 BRUCELLES à tenir les vis avec anneau
de blocage
Screw holding TWEEZERS with locking ring



BR-104 BRUCELLES à pointes fines.
Acier inoxydable
TWEEZERS with fine points. Stainless steel



BR-115 BRUCELLES à pointes très fines.
Acier inoxydable. 110 mm
TWEEZERS with very fine points.
Stainless steel. 110 mm



BR-109 BRUCELLES à becs droits striés
TWEEZERS with straight serrated points



BR-110 BRUCELLES à becs courbes striés.
Acier inoxydable
TWEEZERS with bent serrated points.
Stainless steel



BR-114 BRUCELLES à becs courbes. Titane.
Légères, anti-magnétiques, évitent le dépôt
de soudeuse sur les pointes
TWEEZERS with bent points. Titanium.
Light, antimagnetic, avoiding the solder
deposit on points



BR-111 BRUCELLES auto-serrantes, isolées, droites
Straight nose insulated self-closing
TWEEZERS



BR-112 BRUCELLES auto-serrantes, isolées, courbes
Bent nose insulated self-closing
TWEEZERS



BR-299 BRUCELLES à déclipper les plaquettes
pression
Push-on pad removal TWEEZERS

Cavaliers plastique

Plastic staple sockets

Montages type Silhouette
Silhouette type mountings

Cavaliers plastique (type Silhouette)
Plastic staple sockets (Silhouette type)



Montage métal Metal mounting		Sachet / Bag	
		25 Pcs	100 Pcs
	Douille simple (dure) Single socket (hard) D = 1,4 L = 7 mm	DO-120/25	DO-120/C
	Cavalier (souple) Staple socket (soft) D = 1,4 L = 7 mm	DO-110/25	DO-110/C
	Cavalier (souple) Staple socket (soft) D = 1,4 L = 3 mm	DO-111/25	DO-111/C
	Cavalier (dur) Staple socket (hard) D = 1,6 L = 7 mm	DO-114/25	DO-114/C
	Cavalier trou traversant (mi-dur) Staple socket with through hole (half hard) D = 1,4 L = 7 mm	DO-130/25	DO-130/C
	Cavalier trou traversant (mi-dur) Staple socket with through hole (half hard) D = 1,5 L = 7 mm	DO-131/25	DO-131/C
	Fixation à souder Ø 0,8 mm Fixing shanks to solder Ø 0,8 mm	10 Pcs	
		TI-100/10	

Montage Plastique Plastic mounting		Sachet / Bag	
		25 Pcs	100 Pcs
	Cavalier (dur) Staple socket (hard) D = 2,0 L = 7 mm	DO-112/25	DO-112/C
	Cavalier (dur) Staple socket (hard) D = 2,0 L = 3 mm	DO-113/25	DO-113/C
	Fixations à incruster Ø 1,4 mm Fixing shank to inlay Ø 1,4 mm	10 Pcs	
		TI-110/10	

Clés - Extracteur - Fraises

Wrenches - Extractor - Cutters

Clés pour écrous (suite)

Nut wrenches (cont.)



TO-904 TOURNE ÉCROU UNIVERSEL (3 griffes)
UNIVERSAL NUT TOOL (3 claws)



TO-899 TOURNE ÉCROU pour écrous étoiles de 2,2 mm
WRENCH for 2.2 mm star nuts



TO-900 TOURNE ÉCROU pour écrous hexagonaux de 2,2 mm
WRENCH for 2.2 mm hexagonal nuts



TO-901 TOURNE ÉCROU pour écrous hexagonaux et étoiles de 2,5 mm
WRENCH for 2.5 mm hexagonal and star nuts



TO-910 TOURNE ÉCROU avec éjecteur pour écrous hexagonaux de 2,2 mm. L'éjecteur à ressort permet d'enlever facilement l'écrou de la clé
WRENCH with ejector for 2.2 mm hexagonal nuts. The spring ejector makes the removal of nut from the wrench easy



TO-911 Idem TO-910 mais pour écrous étoiles de 2,2 mm
Same as TO-910 but for 2.2 mm star nuts



TO-912 Idem TO-910 mais pour écrous étoiles de 2,5 mm
Same as TO-910 but for 2.5 mm star nuts

Outils divers

Varied tools



TO-902 TOURNE ÉCROU UNIVERSEL (2 griffes)
UNIVERSAL NUT TOOL (2 claws)



EX-100 EXTRACTEUR de vis cassées
BROKEN SCREW EXTRACTOR



EX-100/1
Lames de rechange pour EX-100 (3 pcs)
Replacement blades for EX-100 (3 pcs)

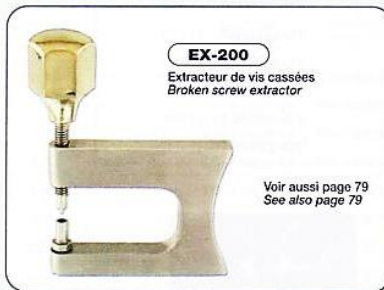

EX-200
Extracteur de vis cassées
Broken screw extractor

Voir aussi page 79
See also page 79



FR-410 FRAISE A ÉBAVURER ET ARRONDIR LES VIS COUPÉES (Ø 2.5)
CUTTER FOR REMOVING ROUGH EDGES FROM CUT SCREWS (Ø 2.5)



FR-410/1
Lame de rechange pour FR-410 (1 pc)
Replacement blade for FR-410 (1 pc)



FR-400 FRAISE POUR CREUSER un emplacement de tête de rivet (Ø ext. = 2,1 mm - Ø int. = 1,1 mm)
CUTTER FOR GROOVING before placing a rivet head



FR-400/1
Lame de rechange (1 pc)
Replacement blade (1 pc)

FRAISES pour réduire les charmons des branches
CUTTERS for reducing the temple barrels



FR-420 FRAISE Ø 2,8 mm
CUTTER Ø 2,8 mm

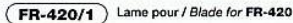

FR-420/1 lame pour / Blade for FR-420



FR-430 FRAISE Ø 3,5 mm
CUTTER Ø 3,5 mm

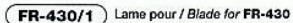

FR-430/1 lame pour / Blade for FR-430



FRAISE avec deux roulettes pour chanfreiner et ébavurer les trous percés dans les verres organiques
Double roller CUTTER for chamfering or removing rough edges from holes drilled in organic lenses

FR-436 roulettes / roller : 2,75 + 3,0 mm

FR-437 roulettes / roller : 3,4 + 3,8 mm











Clés pour écrous

Nut wrenches

Clés pour écrous et pour vis à tête spéciale

Nut wrenches and special head screw wrenches

OUTILS ET LAMES DE RECHANGE POUR CL-122, CL-123 et CL-124 (sachet 1 pc)
REPLACEMENT TOOLS AND BLADES FOR CL-122, CL-123 and CL-124 (bag of 1 pc)

Description (Clé pour type d'écrou / Wrench for nut type)		Manche + Lame / Handle + Blade	Lame seule / Blade only
Etoile 2,2 mm / Star 2.2 mm		 CL-102/A0	 CL-102/B0
Hexagonaux 2,2 mm / Hexagonal 2.2 mm		CL-102/A1	CL-102/B1
Fendus / Slotted		CL-102/A2	CL-102/B2
Etoile 2,8 mm / Star 2.8 mm		CL-102/A3	CL-102/B3
Etoile 2,5 mm / Star 2.5 mm		CL-102/A4	CL-102/B4
Carré / Square		CL-102/A5	CL-102/B5
Hexagonaux 2,5 mm / Hexagonal 2.5 mm		CL-102/A7	CL-102/B7
Etoile 5 branches / 5-point star		CL-102/A8	CL-102/B8

Assortiments de clés pour écrous

Sets of nut wrenches

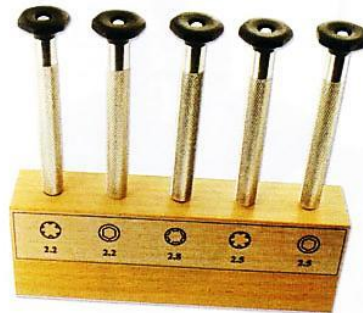

- CL-123** ASSORTIMENT DE CLÉS comprenant :
SET OF NUT WRENCHES including :
- 5 clés de CL-102/A0, 1, 3, 4 et 7 sur support bois
 - 5 nut wrenches CL-102/A0, 1, 3, 4 and 7 on wooden stand



- CL-122** ASSORTIMENT comprenant :
SET including :
- 1 manche CL-102/6 + 5 lames de CL-102/B0, 1, 3, 4 et 7 (en sachet)
 - 1 handle CL-102/6 + 5 blades CL-102/B0, 1, 3, 4 and 7 (in bag)



- CL-124** ASSORTIMENT DE CLÉS POUR ÉCROUS comprenant :
SET OF NUT WRENCHES including :
- 5 clés de CL-102/A0, 1, 3, 4 et 7 en coffret bois
 - 5 nut wrenches CL-102/A0, 1, 3, 4 and 7 in wooden box



- CL-102/6** MANCHE pour / HANDLE for :
CL-102/A0 à/to A8, CL-122, EX-100, TO-111 à/to TO-113

Fournitures Supplies



- 1 CO-100** COLLE AU CYANOACRYLATE verte, prise ultra rapide de 2 à 5 secondes. En tube de 2 g
CYANOACRYLATE SUPER GLUE, green, ultra-quick setting time : 2 to 5 seconds. In 2 g tube
- 2 CO-101** COLLE AU CYANOACRYLATE jaune, temps de prise de 10 à 15 secondes. En tube de 2 g
CYANOACRYLATE SUPER GLUE, yellow, 10 to 15 second setting time. In 2 g tube
- 3 CO-106** LOCTITE 460. Cyanoacrylate compatible avec le polycarbonate. Flacon de 20 g
LOCTITE 460. Cyanoacrylate compatible with polycarbonate. In 20 g bottle
- 4 CO-116** LOCTITE 4850. Cyanoacrylate multi-usages, haute flexibilité, ligne de collage transparente, compatible avec le polycarbonate. Flacon de 20 g
LOCTITE 4850. Cyanoacrylate multi-use, high flexibility, transparent giuing line, compatible with polycarbonate. In 20 g bottle
- 5 CO-119** AIGUILLES DE PRECISION (Ø 0,41 mm) adaptables à **CO-106** et **CO-116** (3 pcs)
PRECISION NEEDLES (Ø 0.41 mm) adaptable to **CO-106** and **CO-116** (3 pcs)



- 6 CO-104** COLLE AU CYANOACRYLATE haute technologie. Multi usages, superpuissante. Application facile et précise. Prise rapide en 5 secondes. En tube de 3 g
High technology CYANOACRYLATE GLUE. Multi-purpose, super strong. Easy and quick application. Quick setting time in 5 seconds. In 3 g tube
- 7 CO-107** COLLE INSTANTANEE EN GEL non coulant - Loctite 454. En tube de 5 g. Embout autopercuteur. Idéal pour surfaces verticales ou inclinées
INSTANT GLUE IN NON RUNNING GEL Loctite 454. In 5 g tube with punching tip. Ideal for vertical or inclined surfaces



- 8 CO-111** PENLOC fixation modérée. Flacon de 50 ml
PENLOC moderate binding. In 50 ml tube
- 9 CO-112** PENLOC ZT pour blocage des vis, temps de prise rapide
En tube de 10 ml
PENLOC ZT, quick setting time. Prevents screws from loosening. In 10 ml tube
- CO-113** PENLOC L pour blocage des vis, temps de prise lent
En tube de 10 ml
PENLOC L slow setting time. Prevents screws from loosening. In 10 ml tube
- 10 CO-115** COLLE POUR COLLAGE PAR UV livrée avec aiguille. En flacon de 10 g. Idéale pour boucher des trous et durcissement sous UV
GLUE FOR STICKING BY UV delivered with punching tip. In 10 g bottle. Ideal for filling drilling holes and for hardening under UV light



- LA-105** LAMPE UV pour durcir les colles du type CO-115. 36 W - Minuterie 180 secondes - 220/240 volts
Dimensions : 275x236x110 mm - Poids : 1,3 kg.
UV LAMP for hardening glues like CO-115. 36 W - Timer 180 seconds - 220/240 volts
Size : 275x236x110 mm - Weight : 1,3 kg
- LA-105/1** AMPOULE DE RECHANGE pour LA-105 (1 pce)
REPLACEMENT BULB for LA-105 (1 pc)

Appareils pour la coloration

Tinting machines

APPAREILS POUR LA COLORATION avec plaques chauffantes indépendantes, régulation automatique pour atteindre et maintenir les températures à environ 93° C. Minuterie pour chaque paire de plaques.
 TINTING MACHINES with independent hot plates, automatic regulation to reach and maintain temperatures at 93° C. Timer for each pair of plates.

AP-390 KIT DE COLORATION
 comprenant :
 TINTING KIT
 including :

- 1 Appareil seul / 1 Machine only (AP-391)
 - 2 Récipients / 2 Pots (2 x AP-405)
 - 2 Pincettes / 2 Lens holders (2 x AP-410)
 - 1 Thermomètre / 1 Thermometer (AP-406)
 - 3 Sachets de colorants / 3 Bags of dyes
- 220/240 volts - Poids / Weight : 4,25 kg
 Dimensions / Size : 420x155x160



AP-400 KIT DE COLORATION
 comprenant :
 TINTING KIT
 including :

- 1 Appareil seul / 1 Machine only (AP-401)
 - 4 Récipients / 4 Pots (4 x AP-405)
 - 4 Pincettes / 4 Lens holders (4 x AP-410)
 - 1 Thermomètre / 1 Thermometer (AP-406)
 - 3 Sachets de colorants / 3 Bags of dyes
- 220/240 volts - Poids / Weight : 8,5 kg
 Dimensions / Size : 420x310x160



AP-415
 PINCE
 en matière
 plastique.
 PLASTIC
 LENS
 HOLDER



TR-800
 TRAITEMENT ANTI-UV
 Absorbe 100% des UV
 de 320 à 380 Nm.
 Produit livré concentré.
 À diluer avec 3 volumes d'eau.
 ANTI-UV TREATMENT
 Absorbs 100% UV
 from 320 to 380 Nm.
 Concentrate to dilute with
 3 volumes of water.



TR-805/35
 TRAITEMENT ANTI-UV
 à diluer dans 1 litre d'eau
 En poudre, sachet de 35 g
 ANTI-UV TREATMENT
 to dilute in 1 liter of water
 In powder, bag of 35 g.

Appareils pour la coloration
Tinting machines



AP-426

- MACHINE A COLORER AU BAIN-MARIE, comprenant :**
- 1 appareil
 - 9 bechers en pyrex 1000 ml (**BE-102**)
 - 9 couvercles (**AP-430**)
 - 2 bidons de 5 litres d'huile de chauffe (**OR-510**)
- BAIN-MARIE TINTING UNIT, including :**
- 1 machine
 - 9 glass beakers 1000 ml (**BE-102**)
 - 9 lids (**AP-430**)
 - 2 drums containing 5 liters heating oil (**OR-510**)

AP-422 option / optional
DEGRADEUR avec pince
GRADUATING UNIT with lens holder

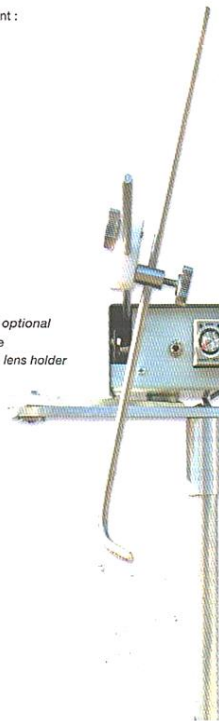

Fournitures pour coloration

Tinting supplies



Pot de 500 g
Pot of 500 g



Sachet de 10 g
Bag of 10 g

COLORANT EN POUVRE pour la coloration des verres organiques
en sachet de 10 g ou en pot de 500 g.
(10 g de colorant en poudre permettent d'obtenir 1 litre de solution colorante)
DYE IN POWDER for tinting organic lenses
in bag of 10 g or in pot of 500 g.
(10 g of dye in powder make one liter of lens dye)

En raison des différences existant entre la coloration des verres et les procédés de reproduction sur papier, les couleurs peuvent être sensiblement différentes, et celles présentées ne sont pas contractuelles. Due to the differences between the lens tinting and the duplicating processes on paper, colours may be perceptibly different. Colours here represented are not contractual.



Marron 1 / Brown 1

CO-800/10 10 g
CO-800/500 500 g



Marron 2 / Brown 2

CO-802/10 10 g
CO-802/500 500 g



Marron 3 / Brown 3

CO-804/10 10 g
CO-804/500 500 g



Fumé 1 / Smoked 1

CO-808/10 10 g
CO-808/500 500 g



Fumé 2 / Smoked 2

CO-810/10 10 g
CO-810/500 500 g



Gris RB / RB Grey

CO-811/10 10 g
CO-811/500 500 g



Bleu / Blue

CO-812/10 10 g
CO-812/500 500 g



Vert 1 / Green 1

CO-814/10 10 g
CO-814/500 500 g

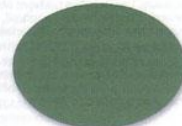

Vert 2 / Green 2

CO-816/10 10 g
CO-816/500 500 g



Jaune / Yellow

CO-818/10 10 g
CO-818/500 500 g



Rose / Pink

CO-820/10 10 g
CO-820/500 500 g



Noir / Black

CO-822/10 10 g
CO-822/500 500 g

Décolorant - Huile de chauffe / Neutralizer - Heating oil



DE-850

DÉCOLORANT LIQUIDE CONCENTRÉ (1 litre)
permet d'obtenir 10 litres
de décolorant
CONCENTRATED NEUTRALIZER
(1 liter) for 10 liters of neutralizer



OR-509

HUILE DE CHAUFFE
pour machines au bain-marie
(bidon d'environ 3 litres)
HEATING OIL
for bain-marie machines
(drum containing about 3 liters)

Embouts

Temple tips

Embouts cylindriques (sachet de 5 paires)
Cylindrical tips (bag of 5 pairs)

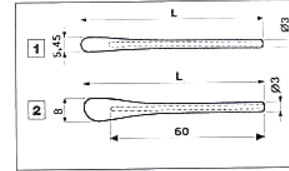

Teintes Colours	Type 1	Type 2				Matière = (a) acétate / acetate (p) propionate / propionate
	L = 65 d = 1.35	L = 65 d = 1.45	L = 70 d = 1.60	L = 75 d = 1.60	L = 65 d = 1.90	
Cristal / Crystal	EM-400/5	EM-430/5	EM-460/5	EM-470/5	EM-480/5	
Bleu / Blue	EM-401/5	EM-431/5	-	-	-	
Vert / Green		EM-432/5	-	-	-	
Gris / Grey	EM-403/5	EM-433/5	-	-	-	
Brun / Brown	EM-404/5	EM-434/5	EM-464/5	EM-474/5	EM-484/5	
Noir / Black	EM-405/5	EM-435/5	EM-465/5	EM-475/5	EM-485/5	
Bordeaux / Dark red	EM-406/5	EM-436/5	-	-	-	
Jaspé écaille clair Light tortoiseshell colour	EM-419/5	EM-449/5	-	-	EM-495/5	
Jaspé écaille foncé Dark tortoiseshell colour	EM-420/5	EM-450/5	-	-	-	

Embouts plats (sachet de 5 paires)
Flat tips (Bag of 5 pairs)

- EM-120/5 Bruyère / Brown
- EM-121/5 Noir / Black

Longueur 70 mm, larg. maxi 7,5 mm,
trou 1,2 x 2,5 mm
Length 70 mm, maxi width 7.5 mm,
hole 1.2 x 2.5 mm



Embouts cylindriques. Acétate (sachet de 5 paires)
Cylindrical tips. Acetate (bag of 5 pairs)

- EM-050/5 Cristal / Crystal
- EM-054/5 Brun / Brown
- EM-055/5 Noir / Black
- EM-059/5 Jaspé écaille clair
Light tortoiseshell colour

Longueur 65 mm. Perçage = long. 60, Ø 1,05
Length 65 mm. Piercing = length 60, Ø 1.05



Embouts ultra-légers (sachet de 5 paires)
Ultra-light tips (Bag of 5 pairs)

- EM-060/5 Cristal / Crystal
- EM-064/5 Brun / Brown
- EM-065/5 Noir / Black
- EM-079/5 Jaspé écaille clair
Light tortoiseshell colour

Longueur 65 mm. Perçage = long. 60, Ø 1,05
Length 65 mm. Piercing = length 60, Ø 1.05



EM-129

ASSORTIMENT DE 30 PAIRES
D'EMBOUITS EN ACÉTATE
(6 x 5 paires)
SET OF 30 PAIRS OF ACETATE
TEMPLE TIPS (6 x 5 pairs)

- Voir tableau ci-contre
See opposite table

TEINTES COLOURS	CASE CASE	RÉFÉRENCE STOCK Nr	PAIRES PAIRS
Brun / Brown	1	EM-064	5
Noir / Black	2	EM-065	5
Brun / Brown	3	EM-404	5
Noir / Black	4	EM-405	5
Brun / Brown	5	EM-434	5
Noir / Black	6	EM-435	5

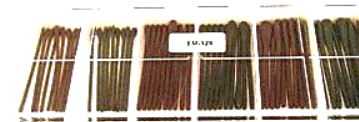

EM-130

ASSORTIMENT DE 30 PAIRES
D'EMBOUITS EN ACÉTATE
(6 x 5 paires)
SET OF 30 PAIRS OF ACETATE
TEMPLE TIPS (6 x 5 pairs)

- Voir tableau ci-contre
See opposite table

TEINTES COLOURS	CASE CASE	RÉFÉRENCE STOCK Nr	PAIRES PAIRS
Cristal / Crystal	1	EM-400	5
Brun / Brown	2	EM-404	5
Noir / Black	3	EM-405	5
Cristal / Crystal	4	EM-430	5
Brun / Brown	5	EM-434	5
Noir / Black	6	EM-435	5

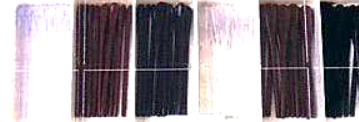

Embouts

Temple tips

Embouts longs cylindriques - Spatule symétrique (sachet de 5 paires)

Long cylindrical tips - Symmetrical end (Bag of 5 pairs)

Teintes Colours	Diam. perçage / Piercing Diam.		Matière Material
	1.05	1.45	
Noir / Black	EM-225/5	EM-205/5	Acétate
Jaspé / Light tortoiseshell colour	EM-239/5	EM-219/5	Propionate



EM-205 et **EM-219** Longueur 123 mm - Perçage = longueur 113 mm / Length 123 mm - Piercing = Length 113 mm

EM-225 et **EM-239** Longueur 130 mm - Perçage = longueur 123 mm / Length 130 mm - Piercing = Length 123 mm

Embouts courts en polymère (Pebax + Cristamid) antiglisse et anallergique

Short polymer tips (Pebax + Cristamid) - No slip - No allergy

Longueur 65 mm - Perçage = longueur 60 mm - Diam. 1,45 mm - Spatule symétrique - Mat (sachet de 5 paires)
Length 65 mm - Piercing = Length 60 mm - Diam. 1.45 mm - Symmetrical end - Unpolished (bag of 5 pairs)

EM-091/5 Bleu / Blue
EM-094/5 Brun / Brown
EM-095/5 Noir / Black



EM-092/5 Vert / Green
EM-096/5 Rouge / Red
EM-098/5 Jaune / Yellow



Embouts en silicone (sachet de 5 paires)

Silicone temple tips (Bag of 5 pairs)

Embouts souples en silicone. Longueur 65 mm. Perçage Ø 1,35 mm
Soft silicone tips. Length 65 mm. Piercing Ø 1.35 mm

EM-140/5 Cristal / Crystal
EM-144/5 Brun / Brown
EM-145/5 Noir / Black

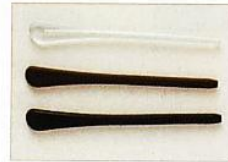

Embouts en silicone extrémité renforcée. Long. 65 mm. Perçage 1,0
Silicone tips strengthened end. Length 65 mm. Piercing 1.0

EM-165/5 Cristal / Crystal
EM-167/5 Noir / Black



Embouts en acétate + gaine silicone. Longueur 70 mm. Perçage Ø 1,2 mm
Acetate tips + silicone temple sleeve. Length 70 mm. Piercing Ø 1.2 mm

EM-180/5 Cristal / Crystal
EM-184/5 Brun / Brown
EM-185/5 Noir / Black
EM-179/5 Jaspé écaille clair / Light tortoiseshell colour



Embouts longs en silicone. Long. 100 mm, Ø intérieur 1,4 mm
Long silicone tips. Length 100 mm, inner Ø 1.4 mm

EM-163/5 Cristal / Crystal
EM-161/5 Noir / Black



EM-132 ASSORTIMENT DE 30 PAIRES D'EMBOUTS EN SILICONE comprenant :
SET OF 30 PAIRS OF SILICONE TEMPLE TIPS including :

- **EM-140/5** à **EM-185/5**
(6 x 5 paires / pairs)



EM-133 ASSORTIMENT DE 30 PAIRES D'EMBOUTS EN POLYMÈRE MAT comprenant :
SET OF 30 PAIRS OF UNPOLISHED POLYMER TIPS including :

- **EM-091/5** à **EM-098/5**
(6 x 5 paires / pairs)

Embouts crochet en silicone

Silicone conversion cable ends

Embouts "Best" (sachet de 1 paire)

Best temple tips (Bag of 1 pair)



1



2

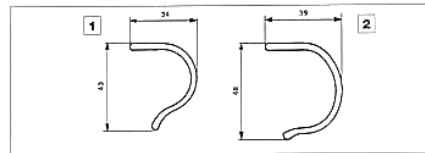

Teintes Colours	Perçage / Piercing Ø 1,35 mm	
	1 Petite taille Small size	2 Grande taille Large size
Blanc / White	—	EM-320/01
Bleu foncé / Dark blue	EM-301/01	EM-321/01
Brun / Brown	EM-302/01	EM-322/01
Noir / Black	EM-303/01	EM-323/01
Gris clair / Light grey	EM-304/01	EM-324/01
Vert / Green	EM-305/01	EM-325/01
Rouge / Red	EM-306/01	EM-326/01
Rouge foncé / Dark red	EM-307/01	EM-327/01
Jaune / Yellow	—	EM-328/01
Beige / Beige	EM-309/01	EM-329/01
Bleu clair / Light blue	EM-310/01	EM-330/01

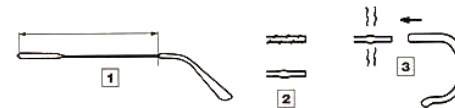

- 1 Couper à la longueur nécessaire.
Cut at the necessary length.
- 2 Cranter à la pince ou aplatir légèrement au marteau.
Notch with a plier or slightly flatten with a hammer.
- 3 Réchauffer l'extrémité coupée (= 150° C) et monter l'embout.
Warm the cut extremity (= 150° C) and mount the tip.

Embouts Standards (sachet de 5 paires)

Standard temple tips (Bag of 5 pairs)



1



2

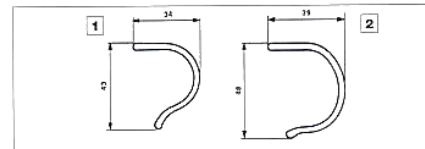

Teintes Colours	Perçage / Piercing Ø 1,35 mm	
	1 Petite taille Small size	2 Grande taille Large size
Blanc / White	-	EM-150/5
Bleu / Blue	EM-191/5	EM-151/5
Brun / Brown	EM-192/5	EM-152/5
Noir / Black	EM-193/5	EM-153/5
Gris / Grey	EM-194/5	-
Vert / Green	EM-195/5	EM-155/5
Rouge / Red	EM-196/5	-
Jaune / Yellow	EM-198/5	EM-158/5



GAINES RÉTRACTABLES en PVC pour la protection contre l'allergie, pour le confort et la décoration.
 Pièces de 200 mm - Diamètre intérieur = 3,2 mm et 2,4 mm.
 Rétraction 50 % sous 120° C
PVC HEAT SHRINK TEMPLE TUBES for protection against allergy, for comfort and decoration.
 Pieces of 200 mm - Inner diameter = 3.2 mm and 2.4 mm.
 Retraction 50 % under 120° C



GAINES RÉTRACTABLES A PLAT - Cristal - Épaisseur : 0,10 mm pour la protection contre l'allergie au nickel
 Rétraction 50 % sous 120° C - Rouleau de 3,3 mètres
FLAT HEAT SHRINK TEMPLE SLEEVES - Crystal - Thickness : 0,10 mm for protection against nickel allergy.
 Retraction 50 % under 120° C - 3.3 meters roll

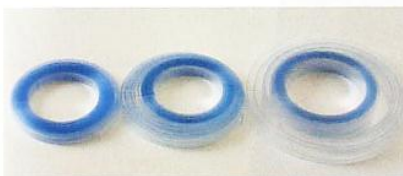

Gaines - Windsorrings

Tubes and Windsor rims

Gaines / Tubes

Teintes Colours	Sachet de 10 pcs / Bag of 10 pcs	
	Gaine diam. 3,2 Tube diam. 3.2	Gaine diam. 2,4 Tube diam. 2.4
Noir / Black	EM-271/10	EM-281/10
Cristal / Crystal	EM-273/10	EM-283/10
Rouge / Red	EM-274/10	-
Bleu / Blue	EM-275/10	-
Jaune / Yellow	EM-276/10	-
Vert / Green	EM-277/10	-
Violet / Violet	EM-278/10	-
Brun / Brown	EM-279/10	-

EM-270 ASSORTIMENT DE 120 PIÈCES de longueur 100 mm d'embouts rétractables comprenant :
SET OF 120 PIECES of 100 mm long heat shrink temple tubes including :

Noir/Black
 Cristal/Crystal
 Rouge/Red
 Bleu/Blue
 Jaune/Yellow
 Vert/Green

(20 pcs de chaque teinte / 20 pcs of each colour)

Typo Type	Diamètre Diameter mm	Largour à plat Flat width mm	Référence Stock number
Étroite / Small	2,5	4	EM-260
Moyenne / Medium	3,2	5	EM-261
Large / Large	4,4	7	EM-262

Windsorrings (rouleau 1,4 mètre) Windsor rims (1.4 meter roll)

- WI-098** Écaille foncé / Dark brown
- WI-099** Écaille clair / Light brown
- WI-110** Gris / Grey

Embouts presse-verre souples

BRIOT



**Embout presse-verre
souple BRIOT
diamètre 25 mm
Sachet de 10 pièces
Réf: EMBOUTBRIOT25**



**Embout presse-verre
souple BRIOT
diamètre 19 mm
Sachet de 5 pièces
Réf: EMBOUTBRIOT19**



**Embout presse-verre
souple BRIOT
diamètre 17 mm plat
Sachet de 5 pièces
Réf: EMBOUTBRIOT17PLAT**

Équarisseurs - Scies

Hand cutting broaches - Saws



Équarisseurs Hand cutting broaches

- EQ-122** Assortiment équarisseurs (1,14 à 2,01)
5 pans manche moleté, en pochette
plastique :
Set of hand cutting broaches (1.14 to 2.01)
5 flutes knurled handle in plastic pouch :
- 6 équarisseurs EQ-100 à EQ-105
 - 6 hand cutting broaches EQ-100 to EQ-105

EQUARRISSEURS AU DÉTAIL (sachet de 3 pièces du même Ø)
HAND CUTTING BROACHES - RETAIL (bag of 3 pieces same Ø)

MANCHE MOLETÉ / KNURLED HANDLE

Réf.	Diam.	Réf.	Diam.
EQ-100	1,14	EQ-103	1,75
EQ-101	1,40	EQ-104	1,90
EQ-102	1,60	EQ-105	2,01

MANCHE CARRÉ / SQUARE HANDLE

Réf.	Diam.	Réf.	Diam.
EQ-110	1,14	EQ-113	1,75
EQ-111	1,40	EQ-114	1,90
EQ-112	1,60	EQ-115	2,01



- EQ-126** Assortiment équarisseurs
manche carré + roule-goupille,
en tube plastique :
Set of hand cutting broaches
square handle + broach holder,
in plastic case :
- 6 équarisseurs EQ-110 à EQ-115
+ 1 roule-goupille
 - 6 hand cutting broaches EQ-110 to EQ-115 + 1 broach holder

EQ-130 : voir/see page 44

Bocfils Saw frames

SU-400

SUPPORT A AGRAFE
pour découpe au bocfil
BENCH PIN and clamp
with slot for cutting with a
saw frame



BO-395 NM

BOCFIL, profondeur 150 mm
structure renforcée
SAW FRAME, depth 150 mm
strengthened structure

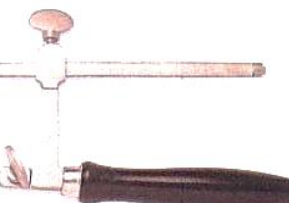
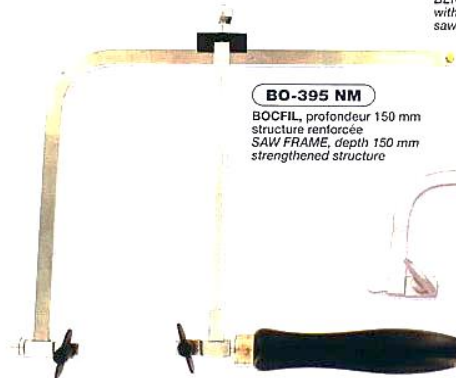

BO-390

BOCFIL, profondeur 60 mm, structure légère
SAW FRAME, depth 60 mm, light structure

LAMES DE BOCFIL / SAW BLADES
Longueur = 130 mm / Length = 130 mm



- BO-405** LAMES DE BOCFIL PLATES pour métaux, 19 dents au cm (12 pcs)
FLAT SAW BLADES for metal, 19 teeth per cm (12 pcs)
- BO-406** LAMES DE BOCFIL PLATES pour plastique, 10 dents au cm (12 pcs)
FLAT SAW BLADES for plastic, 10 teeth per cm (12 pcs)
- BO-410** LAMES DE BOCFIL SPIRALES FINES pour plastique (12 pcs)
FINE SPIRAL TWISTED SAW BLADES for plastic (12 pcs)
- BO-411** LAMES DE BOCFIL SPIRALES MOYENNES pour plastique (12 pcs)
MEDIUM SPIRAL TWISTED SAW BLADES for plastic (12 pcs)

Étaux

Vices



ET-107 ÉTAU en acier et socle aluminium avec mors nylon - Ouverture maximum : 12 mm
Stainless steel VICE and aluminium base with nylon jaws - Maximum opening : 12 mm

ET-107/08 Mors nylon de rechange (paire)
Replacement nylon jaws (pair)



ET-105 ÉTAU à ventouse avec 2 mors caoutchouc largeur 75 mm. Orientable. Se fixe instantanément sur toute surface lisse non poreuse
UNIVERSAL BALL JOINT SWIVEL VICE with vacuum base and 75 mm wide rubber jaws. Attaches instantly to all smooth non porous surfaces.

ET-105/1 Mors caoutchouc de rechange (1 paire)
Replacement set of rubber jaws (1 pair)

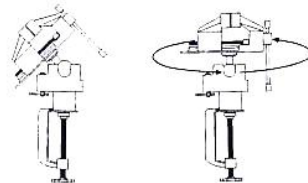

ET-104 ÉTAU ALUMINIUM multi-angles - 75 mm
Montages sur tables de 10 à 52 mm
Pivotant à 360°
MULTI-ANGLE ALUMINIUM VICE - 75 mm
Fits 10 to 52 mm thick benches - Pivoting at 360°



ET-110 ÉTAU à agrafe en acier avec mors largeur 40 mm
Montages sur tables de 10 à 40 mm d'épaisseur
BENCH VICE in steel with 40 mm wide jaws
Fits 10 to 40 mm thick benches



ET-105 ÉTAU à ventouse avec 2 mors caoutchouc largeur 75 mm. Orientable. Se fixe instantanément sur toute surface lisse non poreuse
UNIVERSAL BALL JOINT SWIVEL VICE with vacuum base and 75 mm wide rubber jaws. Attaches instantly to all smooth non porous surfaces.

ET-105/1 Mors caoutchouc de rechange (1 paire)
Replacement set of rubber jaws (1 pair)



ET-120 ÉTAU A MAIN avec vis de blocage - 115 mm
Mâchoires largeur 15 mm - Nickelée
PIN VICE with screw lock - 115 mm
15 mm wide jaws - Nickel plated

ECHELLES D'ACUITE / SIGHT TESTS

EC-301

ECHELLE CHIFFRES
CIPHER SIGHT TEST

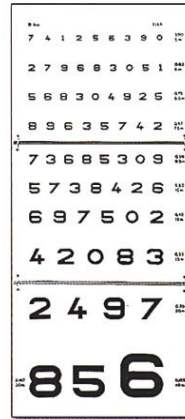

EC-296

ECHELLE ARMAIGNAC
ARMAIGNAC SIGHT TEST



EC-297

ECHELLE DDASS pour enfants
DDASS SIGHT TEST for children



EC-298

ECHELLE PARENT
PARENT SIGHT TEST

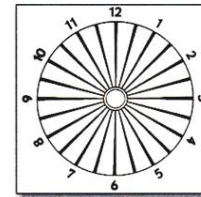

EC-300

ECHELLE MONOYER

Vision de loin.
Lecture à 5 mètres.
Cadran direct 25 x 90 cm
MONOYER SIGHT TEST
Long distance sight (5 meters).
Direct face 25 x 90 cm

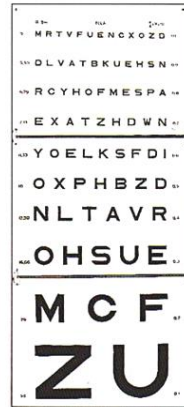

EC-304

ECHELLE DE LECTURE ENFANTS
CHILD TEST CHART



**TESTS D'ISHIHARA
ISHIHARA SIGHT TESTS**

TE-150

38 planches (adulte)
38 plates (adults)

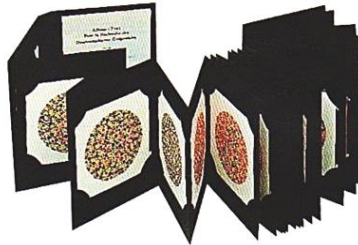

TE-154

14 planches (enfant, figures géométriques)
14 plates (children, geometrical figures)



EC-305

ECHELLE PARINAUD À MAIN
Vision de près
PARINAUD HAND SIGHT TEST
Near distance sight



Examens de vue
Sight testing



VE-400

MALLETTE DE VERRES D'ESSAI
Verres cerclés métal. Mallette en bois 546 x 360 x 65 mm.
260 pièces, comprenant :
- verres concaves sphère : - 0,25 à - 20,0
- verres convexes sphère : + 0,25 à + 20,0
- verres concaves cylindre : - 0,25 à - 6,0
- verres convexes cylindre : + 0,25 à + 6,0
- prismes : 0,5 à 10,0
- accessoires.
Poids : 6,5 kg

TRIAL LENS SET
Lenses with metal rim. Wood carrying case 546 x 360 x 65 mm
260 pieces including :
- concave sphere lenses : - 0.25 to - 20
- convex sphere lenses : + 0.25 to + 20
- concave cylinder lenses : - 0.25 to - 6.0
- convex cylinder lenses : + 0.25 to + 6.0
- prisms : 0.5 to 10.0
- accessories
Weight : 6.5 kg

VE-401

MALLETTE DE VERRES D'ESSAI
156 pièces
TRIAL LENS SET
156 pieces



CY-110

TEST DE CONFIRMATION DES VERRES ± 0,25
Echelle de distance pupillaire réglable
LENS CONFIRMATION TEST ± 0.25
Adjustable PD scale

CY-111

TEST DE CONFIRMATION +/- 0,50
LENS CONFIRMATION TEST +/- 0.50

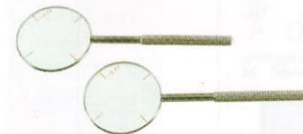

CY-100

CYLINDRES CROISÉS ± 0,25, ± 0,50 (2 pièces)
CROSS CYLINDERS ± 0.25, ± 0.50 (2 pieces)

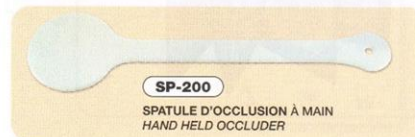

SP-200

SPATULE D'OCCLUSION À MAIN
HAND HELD OCCLUDER



CY-115

TEST MONOCULAIRE ± 0,25
MONOCULAR TEST ± 0.25

CY-116

TEST MONOCULAIRE ± 0,50
MONOCULAR TEST ± 0.50

CY-108

COFFRET TEST MADDOX
rouge et blanc
MADDOX TEST CASE
red and white



LU-385

LUNETTE D'ESSAI ENFANT
CHILD TRIAL FRAME

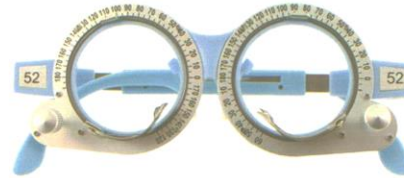

LU-391

LUNETTE D'ESSAI UNIVERSELLE

Permet de recevoir 4 verres d'essai Ø 38 mm de chaque côté.

Plage PD de 48 à 80 mm.

Branches et nez réglables

UNIVERSAL TRIAL FRAME

Has the ability to accommodate 4 trial lenses Ø 38 mm on each side.

PD range from 48 to 80 mm.

Adjustable temples and nose rest

LU-387

LUNETTE D'ESSAI UNIVERSELLE

Permet de recevoir 3 verres d'essai Ø 38 mm.

Très légères.

Plage PD de 50 à 80 mm.

Branches réglables en inclinaison et longueur

UNIVERSAL TRIAL FRAME

Has the ability to accommodate 3 trial lenses Ø 38 mm.

Very light.

PD range from 50 to 80 mm.

Inclination and length of temples can be adjusted

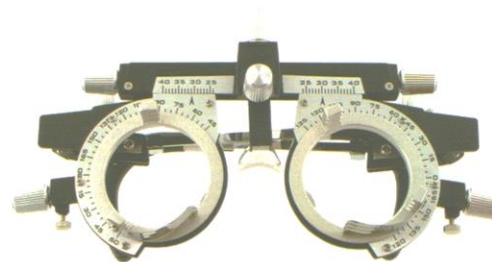

CL-400

CLIPS D'ESSAI
(coffret de 2 pièces)

TRIAL CLIP-ON
(case with 2 pieces)



LA-098

LAMPE STYLO
PEN LAMP



Forets

Drill bits

Assortiments de forets

Sets of drill bits

FO-100 ASSORTIMENT DE FORETS HÉLICOÏDAUX ET TARAUDS comprenant :
SET OF DRILL BITS AND TAPS including :

- 8 forets de diam. 0,8 à 1,5 mm
- 3 tarauds de diam. 1 - 1,2 et 1,4 mm (3 pièces de chaque)
- 8 drill bits Ø 0.8 to 1.5 mm
- 3 taps Ø 1 - 1.2 and 1.4 mm (3 pieces of each)



FO-102 ASSORTIMENT DE FORETS HÉLICOÏDAUX ET EUREKA comprenant :
SET OF TWIST AND EUREKA DRILL BITS including :

- 8 forets hélic. de diam. 0,8 à 1,5 mm
- 4 forets Eureka de diam. 1 - 1,1 - 1,2 et 1,4 mm (3 pièces de chaque)
- 8 twist drill bits Ø 0.8 to 1.5 mm
- 4 Eureka drill bits Ø 1 - 1.1 - 1.2 and 1.4 mm (3 pieces of each)



FO-600 ASSORTIMENT DE FORETS, 10 pcs en carbure de tungstène
Tige Ø 3,175. Bague d'identification en couleur
SET OF DRILL BITS, 10 pcs in tungsten carbide
Shank Ø 3.175. Identification ring in colour



DIAMÈTRE mm DIAMETER mm	RÉFÉRENCE STOCK Nr
0,8	FO-608/1
1,0	FO-610/1
1,1	FO-611/1
1,2	FO-612/1
1,3	FO-613/1
1,4	FO-614/1
1,5	FO-615/1
1,6	FO-616/1
1,8	FO-618/1
2,0	FO-620/1

FO-300 ASSORTIMENT DE FORETS, 10 pcs au diamètre de tige égal au diamètre de perçage **FO-308 à FO-318**
SET OF DRILL BITS, 10 pcs shank diameter equal to drilling diameter **FO-308 to FO-318**



Forets en sachet

Drill bits in bag

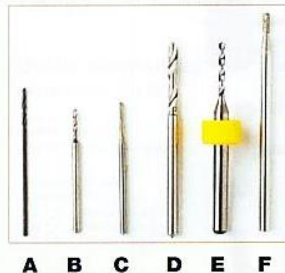

Diamètre Diameter mm	SACHET / BAG					
	3 pcs			1 pc		
	A	B	C	D	E	F
	HÉLICOÏDAUX TWIST Standard (1)	HÉLICOÏDAUX RENFORCÉS TWIST STRONG SHANK (2)	EUREKA (2)	HÉLICOÏDAUX TWIST (3)	HÉLICOÏDAUX CARBURE TWIST CARBIDE (4)	DIAMANTÉS DIAMOND (3)
	Acier outil Tool steel	Acier HSS HSS steel	Acier HSS HSS steel	Acier outil Tool steel	Carbure de tungstène Tungsten carbide	Acier outil Tool steel
0,5	-	FO-005/3	-	-	-	-
0,6	-	FO-006/3	-	-	-	-
0,7	-	FO-007/3	-	FO-507/1	-	-
0,8	FO-308/3	FO-008/3	FO-208/3	FO-508/1	FO-608/1	-
0,9	FO-309/3	FO-009/3	FO-209/3	FO-509/1	FO-609/1	-
1,0	FO-310/3	FO-010/3	FO-210/3	FO-510/1	FO-610/1	-
1,1	FO-311/3	FO-011/3	FO-211/3	FO-511/1	FO-611/1	-
1,2	FO-312/3	FO-012/3	FO-212/3	FO-512/1	FO-612/1	FO-412/1
1,3	FO-313/3	FO-013/3	FO-213/3	FO-513/1	FO-613/1	-
1,4	FO-314/3	FO-014/3	FO-214/3	FO-514/1	FO-614/1	FO-414/1
1,5	FO-315/3	FO-015/3	FO-215/3	FO-515/1	FO-615/1	-
1,6	FO-316/3	FO-016/3	FO-216/3	-	FO-616/1	-
1,7	-	FO-017/3	-	-	FO-617/1	-
1,8	FO-318/3	FO-018/3	-	-	FO-618/1	FO-418/1
1,9	-	FO-019/3	-	-	FO-619/1	-
2,0	-	FO-020/3	-	-	FO-620/1	-
2,1	-	FO-021/3	-	-	-	-
2,2	-	FO-022/3	-	-	-	-
2,4	-	FO-024/3	-	-	-	-

(1) Tige = Diamètre foret / Shank = Drill bit diameter
 (2) Tige / Shank = Ø 1,5 : Forets de 0,5 à 1,5 mm - Drill bits from 0.5 to 1.5 mm
 Ø 2,0 : Forets de 1,6 à 2,0 mm - Drill bits from 1.6 to 2.0 mm
 Ø 2,5 : Forets de 2,1 à 2,4 mm - Drill bits from 2.1 to 2.5 mm
 (3) Tige / Shank = Ø 2,35 - (4) Tige / Shank = Ø 3,175

Fraises

Cutters

Ronde / Round \varnothing 2,0 : FR-301/020
Sachet / Bag : 2 pcs \varnothing 2,5 : FR-301/025

Conique / Conical \varnothing 2,0 : FR-302/020
Sachet / Bag : 2 pcs \varnothing 3,0 : FR-302/030

Cylindrique / Cylindrical \varnothing 2,0 : FR-303/020
Sachet / Bag : 2 pcs \varnothing 2,5 : FR-303/025
 \varnothing 3,0 : FR-303/030
 \varnothing 3,5 : FR-303/035
 \varnothing 4,0 : FR-303/040

Cuvette / Cup \varnothing 1,8 : FR-304/018
Sachet / Bag : 2 pcs \varnothing 2,3 : FR-304/023

Biconique 45°
45° Biconical Sachet / Bag : 1 pc \varnothing 2,9 : FR-305/029
 \varnothing 3,7 : FR-305/037

Scie (à fendre les lêtes de vis)
Saw (screw head cutter) Sachet / Bag : 1 pc \varnothing 2,3 x 0,2 : FR-306/023
 \varnothing 4,0 x 0,3 : FR-306/040

Disque biconique
Biconical disc Sachet / Bag : 1 pc \varnothing 6,0 : FR-307/060
 \varnothing 8,0 : FR-307/080

Fraises au carbure de tungstène

Tungsten carbide cutters

Ronde / Round \varnothing 0,8 : FR-351/008
Tige / Shank \varnothing 2,35 \varnothing 0,9 : FR-351/009
Sachet / Bag : 1 pc \varnothing 1,0 : FR-351/010
 \varnothing 1,2 : FR-351/012

Fraise pour polaroid
Cutter for polaroid Tige / Shank \varnothing 2,35 Sachet / Bag : 1 pc \varnothing 2,3 : FR-325/023



FR-120 ASSORTIMENT DE FRAISES en acier outil comprenant :
SET OF CUTTERS in cast steel including :

* 12 fraises / 12 cutters :
FR-301/020 FR-301/025 FR-301/030
FR-302/020 FR-302/030 FR-303/020
FR-303/030 FR-304/018 FR-304/023
FR-305/029 FR-306/023 FR-307/080

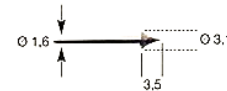

FR-385
FRAISE DIAMANTÉE CONIQUE.
Pour ébavurer à la main
(à monter sur un roule gouille).
CONICAL DIAMOND CUTTER.
(to mount on a holder).

Fraises au carbure de tungstène pour Polycarbonate

Tungsten carbide cutters for Polycarbonate

\varnothing mm DIAM. mm	COULEURS BAGUE RING COLOURS	RÉFÉRENCE ITEM NUMBER
0,8	rose / pink	FR-317/008
0,9	rose foncé / dark pink	FR-317/009
1,0	vert pâle / light green	FR-317/010
1,1	bleu / blue	FR-317/011
1,2	brun / brown	FR-317/012
1,3	jaune / yellow	FR-317/013
1,4	orange / orange	FR-317/014
1,5	gris / grey	FR-317/015
1,6	vert foncé / dark green	FR-317/016
1,8	rouge / red	FR-317/018
2,0	violet / violet	FR-317/020

FR-317

ASSORTIMENT en boîte de 10 FRAISES AU CARBURE DE TUNGSTÈNE (FR-317/008 à FR-317/020)
SET OF 10 TUNGSTEN CARBIDE CUTTERS in box (FR-317/008 to FR-317/020)

FRAISES AU CARBURE DE TUNGSTÈNE à denture croisée

TUNGSTEN CARBIDE CUTTERS with crossed teeth

\varnothing mm DIAM. mm	Référence Stock Nr	Couleurs bague Colours
0,8	FR-318/008	rose / pink
0,9	FR-318/009	rose foncé / dark pink
1,0	FR-318/010	vert pâle / light green
1,1	FR-318/011	bleu / blue
1,2	FR-318/012	brun / brown
1,3	FR-318/013	jaune / yellow
1,4	FR-318/014	orange / orange

FR-318

ASSORTIMENT en boîte de 7 FRAISES AU CARBURE DE TUNGSTÈNE à denture croisée (FR-318/008 à FR-318/014)
SET OF 7 TUNGSTEN CARBIDE CUTTERS in box (FR-318/008 to FR-318/014)

1 **VE-156/5** Système Huvitz (petit/small)



2 **VE-157/5** Système Huvitz (grand/large)

3 **VE-163/5** Système Weco, 25 x 20 mm pour verres à forte cambrure (5 pcs) / for lenses with high curvature



4 **VE-164/5** Système Weco, 25 mm pour verres à forte cambrure (5 pcs) / for lenses with high curvature

5 **VE-165/5** Système Weco plast. 20 mm (5 pcs)

6 **VE-166/5** Système Weco plast. 25 mm (5 pcs)



7 **VE-167/10** Système Essilor 18 mm (10 pcs)

8 **VE-168/20** Système Essilor 25 mm (20 pcs)

9 **VE-169/10** Système Essilor orange (10 pcs)

10 **VE-169/50** Système Essilor orange (50 pcs)

11 **VE-170/5** Système Briot plast. 25 mm (5 pcs)



12 **VE-173/5** Système Briot plast. 19 mm (5 pcs)

13 **VE-174/5** Système Nidek petit/small (5 pcs)



14 **VE-175/5** Système Nidek grand/large (5 pcs)

15 **VE-176/5** Système Takubo petit/small (5 pcs)



16 **VE-177/5** Système Takubo moyen/medium (5 pcs)

17 **VE-178/5** Système Takubo grand/large (5 pcs)

18 **VE-179/5** Bloc universel Weco 25 x 20 mm (5 pcs)



19 **VE-180/10** Blocs Nidek (5 rouge/red + 5 vert/green)



20 **VE-181/5** Blocs Nidek (5 rouge/red)

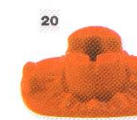

21 **VE-182/5** Blocs Nidek (5 vert/green)

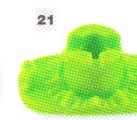

Instruments de mesure

Measuring instruments

Pieds à coulisse Sliding calipers



PI-309 PIED À COULISSE DIGITAL 100 mm
au 1/100^e (mm ou pouce)
ELECTRONIC DIGITAL CALIPER 100 mm
1/100^e (mm or inches)



PI-310/1 PILE DE RECHANGE pour PI-309 et PI-310 (pce)
REPLACEMENT BATTERY for PI-309 and PI-310

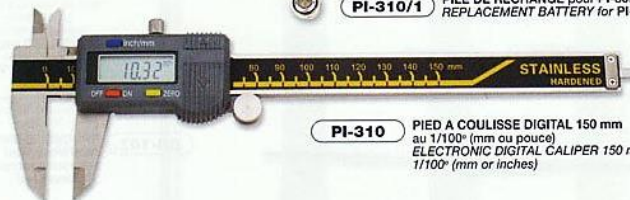

PI-310 PIED À COULISSE DIGITAL 150 mm
au 1/100^e (mm ou pouce)
ELECTRONIC DIGITAL CALIPER 150 mm
1/100^e (mm or inches)

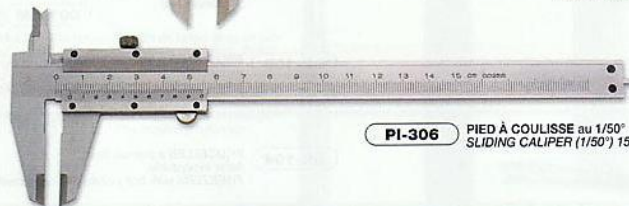

PI-306 PIED À COULISSE au 1/50^e 150 mm
SLIDING CALIPER (1/50^e) 150 mm

Réglets / Rulers

RE-104

REGLET
métallique 150 mm
STEEL RULER
150 mm



RE-105

REGLET
métallique 200 mm
STEEL RULER
200 mm



RE-110

REGLET OPTICIEN
(Type A)
Optician RULER
(A type)



RE-111

REGLET OPTICIEN
(Type B)
Optician RULER
(B type)



RE-112

REGLET OPTICIEN
(Type C)
Optician RULER
(C type)



RE-113

REGLET OPTICIEN
(Type D)
Optician RULER
(D type)



RE-115

REGLE LOUPE
200 mm
MAGNIFIER
RULER 200 mm



Instruments de mesure

Measuring instruments



SP-100NM

SPHEROMÈTRE avec pointes saphir.
Capacité : ± 20 dioptries. Echelles : 1,53 + 1,7
La valeur en dioptries du verre est obtenue par l'addition des mesures lues sur les deux faces du verre.
Exemple : + 5 une face, - 3 autre face = 2 dioptries
LENS CLOCK with sapphire tips.
Capacity : ± 20 diopters. Scales : 1.53 + 1.7
Add the measures read on both faces of the lens to obtain the diopter value of the glass.
Ex. : + 5 on one face, - 3 on the other face = 2 diopters



SP-101NM

SPHEROMÈTRE muni d'une aiguille de mémorisation de la première mesure.
Autres caractéristiques : identiques à SP-100 NM
LENS CLOCK with a hand memorizing the first measure.
Other features : same as SP-100 NM



SP-099

SPHEROMÈTRE avec pointes métal
Capacité ± 20 dioptries. Echelle : 1,53
LENS CLOCK with metal tips.
Capacity ± 20 diopters. Scale : 1.53



RE-150

RÈGLE DE CONTRÔLE de montage des verres. Permet de vérifier les alignements et hauteurs.
CONTROL MEASURE for mounting lenses. For checking lines and heights.

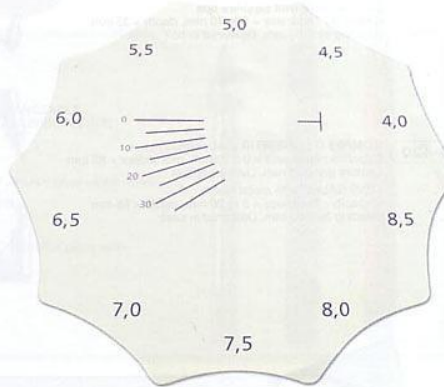

JA-100

JAUGE de la base des verres de 4,5 à 8,5
GAUGE for measuring the lens basis from 4.5 to 8.5

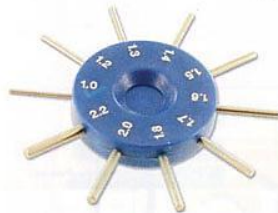

JA-105

JAUGE du diamètre des perçages, des diamètres 1,0 à 2,2 mm
GAUGE for measuring the drilling diameters from 1.0 to 2.2 mm



RE-120

REGLET DE MESURE des hauteurs des segments de bifocaux. Sachet de 1 paire.
RULER for measuring heights of bifocal segments.
Bag of 1 pair.

Instruments de mesure

Measuring instruments

OU-101 OUTIL avec pointes nylon pour mesurer l'épaisseur des verres
LENS GAUGE with nylon tips for measuring lens thickness

OU-101/1 Pointes de rechange (1 paire)
 Replacement tips (1 pair)



OU-102 OUTIL avec pointes nylon, mâchoires larges
LENS GAUGE with wide jaws and nylon tips for measuring lens thickness

OU-101/1 Pointes de rechange (1 paire)
 Replacement tips (1 pair)



CO-418 COMPAS D'ÉPAISSEUR avec pointes saphir
 Capacité : épaisseur = 0 à 10 mm, profondeur = 35 mm
 Lecture par 0,05 mm. Livré en boîte
LENS GAUGE with sapphire tips
 Capacity : Thickness = 0 to 10 mm, depth = 35 mm
 Reading by 0.05 mm. Delivered in box.



CO-420 COMPAS D'ÉPAISSEUR avec pointes métal
 Capacité : épaisseur = 0 à 20 mm, profondeur = 85 mm
 Lecture par 0,05 mm. Livré en coffret
LENS GAUGE with metal tips
 Capacity : Thickness = 0 to 20 mm, depth = 85 mm
 Reading by 0.05 mm. Delivered in case

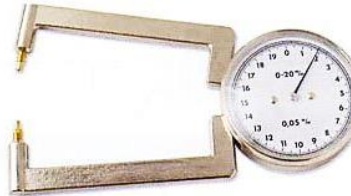

RA-400
 RAPPORTEUR D'ANGLE en acier inoxydable, 200 mm
 BEVEL PROTRACTOR in stainless steel, 200 mm

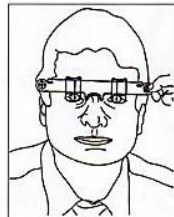

RE-190
 PUPILLOMETRE DE POCHE
 Comporte des curseurs qui se placent au centre de la pupille pour mesure de PD. Mesure également la hauteur des segments pour verres bifocaux, trifocaux et progressifs

POCKET PUPILOMETER
 Ruler with slides which move to center of pupil to measure PD. Also measures seg height for bifocal, trifocal and progressive lenses



Limes

Files

Limes mécaniques / Engineer files



PLATES / FLAT



MI-RONDES / HALF-ROUND



RONDES / ROUND

LIMES MÉCANIQUES ENGINEER FILES					LIMES DE PRÉCISION PRECISION FILES		
	LIMES PLATES FLAT HAND FILES	LIMES MI-RONDES HALF-ROUND FILES	LIMES RONDES ROUND FILES			LIMES FEUILLE DE SAUGE CROSSING FILES	
Section Taille Cut	150 x 15 x 3,5	150 x 16 x 4,5	100 x 4	150 x 6	Section Taille Cut	100 x 11 x 4	150 x 15 x 4,5
BATARDE BASTARD	LI-110	LI-113			00		LI-093
MI-DOUX SECOND	LI-111	LI-114					
DOUX SMOOTH	LI-112	LI-115	LI-108	LI-118	2	LI-092	

Limes spéciales / Special files



LI-130

LIME PLATE DOUBLE TAILLE (taille 0 un côté, taille 2 autre côté) 135 x 12 x 3 mm
FLAT HAND FILE DOUBLE CUT (cut 0 one side, cut 2 other side) 135 x 12 x 3 mm



LI-165

LIME MI-RONDE pour plastique et caoutchouc (taille spéciale) 115 x 14 x 4,5 mm
HALF-ROUND FILE for plastic and rubber (special cut) 115 x 14 x 4,5 mm



LI-250/50

LIME A FENDRE 75 x 9,5 x 0,5 mm
SCREW HEAD FILE 75 x 9,5 x 0,5 mm



LI-252

LIME AIGUILLE PLATE RECOUBÉE (taille 2) 60 x 5 x 1,2
Permet de limer l'extrémité des vis en évitant le risque de rayer la monture
SCREW FINISHING FILE (cut 2) 60 x 5 x 1,2
For filing the extremity of screws avoiding the risk of scratching the frame

LI-147

ASSORTIMENT DE 6 LIMES AIGUILLES
(plate, mi-ronde, ronde, triangulaire, carrée, entrée)
longueur 100 mm, taille 2 (recommandé pour montages Silhouette) voir pages 4 à 6
SET OF 6 NEEDLE FILES
(flat, half-round, round, triangle, square, pointed)
length 100 mm, cut 2 (recommended for Silhouette mountings) see pages 4 to 6



Limes aiguilles

Needle files

Limes aiguilles (longueur 140 mm) / Needle files (length 140 mm)

Taille / Cut				
0	2			
LI-170	LI-150	Plate / Flat		
LI-171	LI-151	Mi-ronde / Half-round		
LI-172	LI-152	Ronde / Round		
LI-173	LI-153	Entrée / Pointed		
LI-174	LI-154	Triangulaire / Triangle		
LI-175	LI-155	Carrée / Square		
LI-177	LI-157	Feuille de sauge / Crossing		

Assortiment de limes aiguilles (longueur 140 mm)
Set of needle files (length 140 mm)

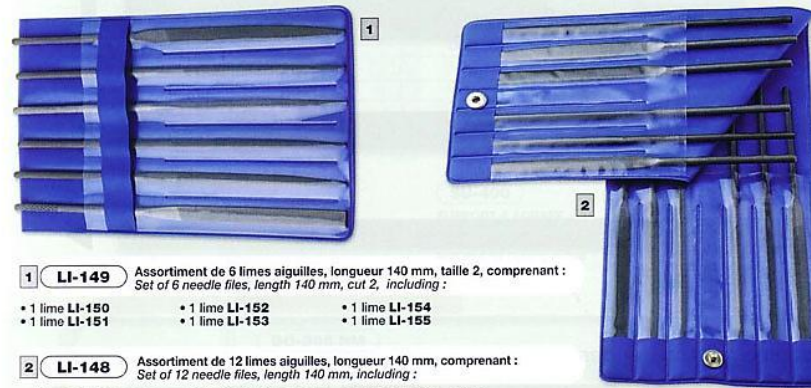

1 LI-149 Assortiment de 6 limes aiguilles, longueur 140 mm, taille 2, comprenant :
Set of 6 needle files, length 140 mm, cut 2, including :

- 1 lime LI-150
- 1 lime LI-151
- 1 lime LI-152
- 1 lime LI-153
- 1 lime LI-154
- 1 lime LI-155

2 LI-148 Assortiment de 12 limes aiguilles, longueur 140 mm, comprenant :
Set of 12 needle files, length 140 mm, including :

- 1 lime LI-170 (taille/Cut 0)
- 1 lime LI-172 (taille/Cut 0)
- 1 lime LI-173 (taille/Cut 0)
- 1 lime LI-174 (taille/Cut 0)
- 1 lime LI-177 (taille/Cut 0)
- 1 lime LI-150 (taille/Cut 2)
- 1 lime LI-151 (taille/Cut 2)
- 1 lime LI-152 (taille/Cut 2)
- 1 lime LI-153 (taille/Cut 2)
- 1 lime LI-154 (taille/Cut 2)
- 1 lime LI-155 (taille/Cut 2)
- 1 lime LI-157 (taille/Cut 2)

Limes aiguilles coulisses / Needle joint files

Bords taillés seulement. Permettent de faire des encoches. Longueur 160 - Taille 2
Cut edges only. For making notches. Length 160 - Cut 2



Limes aiguilles diamantées / Diamond needle files

Limes aiguilles diamantées, long. 120, grain 125/100
Diamond needle files, length 120, fineness 125/100



Limes

Files

Râpe fine piqûre (longueur 150 mm) / Rasp with fine pitting (length 150 mm)



LI-280 RÂPE, mi-ronde, Fine piqûre
Half round RASP - Fine pitting

Limes cylindriques Longueur totale = 145 mm, Longueur utile = 95 mm

Cylindrical Files Total length = 145 mm, Useful length = 95 mm

LI-139 Diamètre 1,0
Diameter 1.0



LI-141 Diamètre 1,2
Diameter 1.2



LI-138 Assortiment / Set (LI-139 + LI-141)

Limes Eméri Longueur totale = 250 mm, Longueur utile = 210 mm

Emery Files Total length = 250 mm, Useful length = 210 mm



LI-400/0 Plate, Grain = 400
Flat, Grit = 400



LI-401/0 Mi-ronde, Grain = 400
Half round, Grit = 400



LI-404/0 Triangulaire, Grain = 400
Triangular, Grit = 400

Accessoires / Accessories



CA-100 CARDE À LIME
FILE CLEANER



LI-320 PROTÈGE MONTURE
pendant les opérations de limage
FILE GUARD
Protects frame when filing

MANCHES / HANDLES



LI-300 MANCHE BOIS Ø 12 mm (3 pcs)
WOOD HANDLE Ø 12 mm (3 pcs)



LI-302 MANCHE BOIS Ø 16 mm (3 pcs)
WOOD HANDLE Ø 16 mm (3 pcs)



LI-304 MANCHE PLASTIQUE Ø 16 mm (3 pcs)
PLASTIC HANDLE Ø 16 mm (3 pcs)



LI-305 MANCHE UNIVERSEL pour limes aiguilles (1 pc)
UNIVERSAL HANDLE for needle files (1 pc)

Loupes Magnifiers

LOUPE ECLAIRANTE
ILLUMINATING MAGNIFIER

LO-111 Ø 90 - 2,5 X



LO-132

LOUPE SUR PIEDS
Manche et pieds repliables.
Dimensions : 50 x 85 mm. Grossissement : 3,5 X
STAND MAGNIFIER
Folding handle and stands.
Size : 50 x 85 mm. Magnification : 3.5 X

LO-135

LOUPE DE BRODEUSE
Verre organique bifocal.
Monture cristal.
Dimensions : 100 x 140 mm.
Grossissement : 1,8 X
EMBROIDERY MAGNIFIER
Bifocal organic lens.
Crystal colour frame
Size : 100 x 140 mm.
Magnification : 1.8 X



LO-146

LOUPE DOUBLE PLIANTE
Grossissements : Ø 18 = X 10 / Ø 12 = X 20
DOUBLE FOLDING MAGNIFIER
Magnifications : Ø 18 = X 10 / Ø 12 = X 20



LO-120

LOUPE DE POCHE ECLAIRANTE
ILLUMINATING POCKET MAGNIFIER

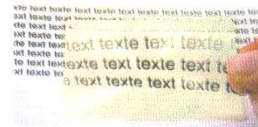

LO-140

LOUPE DE FRESNEL
FRESNEL MAGNIFIER

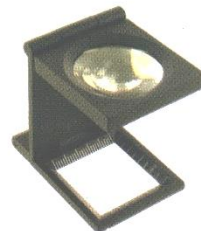

CO-440

COMPTE-FILS AVEC ECHELLE
Dimensions : 30 x 30 mm.
Grossissement : 6 X
THREAD COUNTER WITH SCALE
Size : 30 x 30 mm.
Magnification : 6 X



LO-145

LOUPE PLIANTE
Grossissement X 10
FOLDING MAGNIFIER
Magnification X 10



LO-150

LOUPE D'HORLOGER
Grossissement X 10
WATCHMAKER MAGNIFIER
Magnification X 10

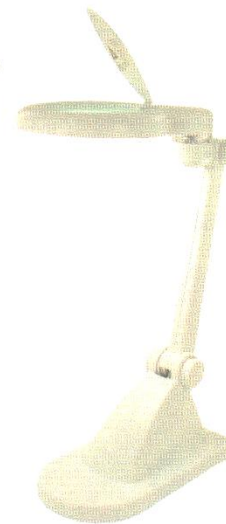

LO-133

LAMPE LOUPE AVEC CIRCLINE
Grossissements : 1,75 X et 4 X
SWING MAGNIFYING LAMP WITH CIRCLINE
Magnifications : 1.75 X and 4 X

Faces relevables
avec verres grossissants +1 à +3

Flip-up clips with +1 to +3 magnifying lenses

GRAND MODÈLE / LARGE MODEL



- FA-160/10** Verres AC + 1.0 / AC + 1.0 Lenses
- FA-160/15** Verres AC + 1.5 / AC + 1.5 Lenses
- FA-160/20** Verres AC + 2.0 / AC + 2.0 Lenses
- FA-160/25** Verres AC + 2.5 / AC + 2.5 Lenses
- FA-160/30** Verres AC + 3.0 / AC + 3.0 Lenses

MODÈLE DEMI-LUNE / HALF FRAME MODEL



- FA-161/10** Verres AC + 1.0 / AC + 1.0 Lenses
- FA-161/15** Verres AC + 1.5 / AC + 1.5 Lenses
- FA-161/20** Verres AC + 2.0 / AC + 2.0 Lenses
- FA-161/30** Verres AC + 3.0 / AC + 3.0 Lenses

PETIT MODÈLE / SMALL MODEL



- FA-162/10** Verres AC + 1.0 / AC + 1.0 Lenses
- FA-162/20** Verres AC + 2.0 / AC + 2.0 Lenses
- FA-162/30** Verres AC + 3.0 / AC + 3.0 Lenses

Lunettes de maquillage

Monture métallique dorée.
Emboutis jaspés, verres vissés changeables
Make-up glasses
Gold metal frame, screwed up changeable lenses.
Light tortoiseshell colour tips



- LU-300/20** Verres AC + 2.0 / AC + 2.0 lenses
- LU-300/25** Verres AC + 2.5 / AC + 2.5 lenses
- LU-300/30** Verres AC + 3.0 / AC + 3.0 lenses

Monture plastique
Plastic frame



- LU-301/15** Verres AC + 1.5 / AC + 1.5 lenses
- LU-301/20** Verres AC + 2.0 / AC + 2.0 lenses
- LU-301/25** Verres AC + 2.5 / AC + 2.5 lenses
- LU-301/30** Verres AC + 3.0 / AC + 3.0 lenses

Pansements orthoptiques 3M opticlude

Recommandés lors du traitement de l'amblyopie et du strabisme.
Boîte de 20 pansements.

3M opticlude orthoptic eye patches

Recommended for treatment of amblyopia and strabismus.
Box of 20 patches.



PA-299
Illustré, modèle junior
Illustrated, junior type



PA-300
Modèle junior
Junior type



PA-301
Modèle adulte
Adult type

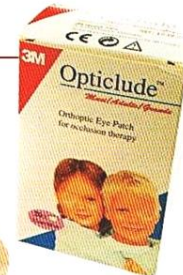

Ensembles

Tool sets and mounting supplies

Ensembles d'outillage / Tool kits

TR-211 TROUSSE D'OUTILLAGE comprenant : TOOL POUCH including :

- PI-105/E Pince coupante latérale / Side cutting plier
- PI-108/E Pince à chaîne / Chain nose plier
- PI-130/E Pince à incliner / Inclination plier
- PI-107/E Pince à tenons / Temple angling plier
- TO-130 Tournevis / Screwdriver
- RE-110 Règle optique / Optician ruler
- BR-104 Brucelles à pointes fines / Tweezers with fine point
- TO-902 Tourne-vis universel / Universal nut tool
- 2 Tubes de vis / 2 tubes with screws
- 2 Tubes de plaquettes / 2 tubes with nose pads

MA-211 MALLETE D'OUTILLAGE comprenant : TOOL CASE including :

- PI-103/S Pince à plaquettes / Pad adjusting plier
- PI-105/S Pince coupante latérale / Side cutting plier
- PI-152/S Pince à chaînes / Chain nose plier
- PI-130/S Pince à incliner / Inclination plier
- PI-133/S Pince à ménisquer / Nylon Eyewire forming plier
- PI-107/S Pince à tenons / Temple angling plier
- PI-116/S Pince à aiguiser / Glass chipping plier
- BR-104 Brucelles à pointes fines / Tweezers with fine point
- TO-130 Tournevis à lames / 4 blade screwdriver
- PO-099 Pointe à tracer / Scriber
- PO-096 Pointe à tracer carbure / Carbide scriber
- BO-099 Bouterolle / Cup punch
- CH-039 Chasse-goupille / Blunt punch
- RO-100 Roule-goupille / Brush holder
- GR-100 Gratteur / Scraper
- CO-600 Coupe verre / Glass cutter
- RE-105 Règle 20 cm / 20 cm ruler
- PI-306 Pied à coulisse 150 / Slide caliper 150
- MA-101/BD Marteau / Hammer
- BO-395 Boef / prof. 150 / Saw frame depth 150
- BO-405 Lames pour métaux / Blades for metal
- BO-410 Lames pour plastique / Blades for plastic
- EQ-129 Equerre / Hand cutting brackets (2 pcs)
- FO-010 Forets Ø 1,0 mm / 1,0 mm Ø drill bits (2 pcs)
- TA-012 Tarauds Ø 1,2 mm / 1,2 mm Ø taps (2 pcs)
- LI-150 Lime aig. plate taille 2 / Flat needle file cut 2
- LI-151 Lime aig. m-ronde taille 2 / Half-round needle file cut 2
- LI-152 Lime aig. ronde taille 2 / Round needle file cut 2
- LI-110 Lime plate biseau / Flat file bastard
- LI-111 Lime plate mi-doux / Flat file second cut
- LI-113 Lime m-ronde biseau / Half-round file bastard
- LI-115 Lime m-ronde creux / Half-round file smooth
- CA-100 Carte à lime / File cleaner



Fournitures pour montages / Mounting supplies



FO-800 FOURNITURES POUR FAÇONNAGE de monture plastique - Plaque en acétate
SUPPLIES for plastic frame - Plate in acetate



PR-200/01 PROFIL de cercle métal, 1 mètre
PROFILE of metal circle, 1 meter



FO-810 FOURNITURES POUR MONTAGE de monture métal (éléments métalliques bruts)
SUPPLIES for metal frame mounting (rough metal elements)



FO-815 FOURNITURES POUR MONTAGE de verres percés (éléments métalliques bruts)
SUPPLIES for pierced lens mounting (rough metal elements)

Marteaux - Pointeaux

Hammers - Punches

Marteaux / Hammers

1 MA-101/80

MARTEAU type horloger. Tête largeur 80 mm
Nickelée - Manche en bois - Poids 80 g
SWISS STYLE HAMMER, 80 mm wide head
Nickel plated - Wooden handle - Weight 80 g

2 MA-101/90

MARTEAU type horloger. Tête largeur 90 mm
Nickelée - Manche en bois - Poids 110 g
SWISS STYLE HAMMER, 90 mm wide head
Nickel plated - Wooden handle - Weight 110 g

3 MA-102

MARTEAU A RIVER. Tête largeur 75 mm
Chromée - Manche en bois - Poids 100 g
RIVETING HAMMER, 75 mm wide head
Chromium plated - Wooden handle - Weight 100 g

4 MA-100

MAILLET. Tête largeur 80 mm en laiton avec un
embout nylon d'un côté. Manche en aluminium. Poids
80 g
MALLET, 80 mm wide head, Brass with a nylon
tip on one side, Aluminium handle - Weight 80 g

MA-100/1 Embout nylon de rechange
Replacement nylon tip

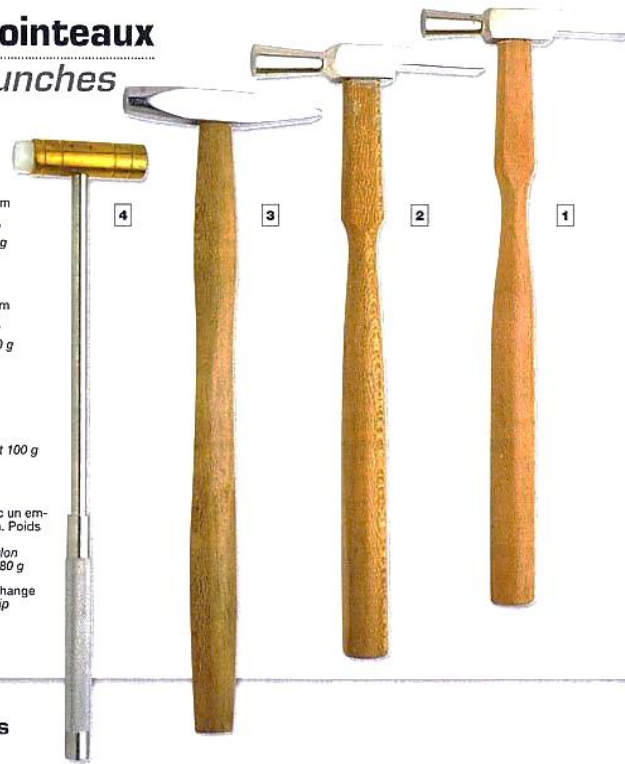

Pointeaux - Bouterolles

Chasse goupilles

Punches - Cup punches

Blunt punches



CH-038 CHASSE GOUPILLE conique.
Diamètre à l'extrémité : 1 mm - Manche moleté - Nickelé
BLUNT PUNCH conical, Diameter at the end : 1 mm
Milled handle - Nickel plated



CH-039 CHASSE GOUPILLE avec pointe interchangeable
de diam. 0,9 mm - Manche moleté - Nickelé
BLUNT PUNCH with interchangeable pin diam. 0,9 mm
Milled handle - Nickel plated

CH-039/1 Pointes de rechange (3 pcs)
Replacement pins (3 pcs)



PO-080 POINTEAU - Manche moleté - Nickelé
POINTED PUNCH - Milled handle - Nickel plated



BO-099 BOUTEROLLE Ø 1,6 mm - Manche moleté - Nickelé
CUP PUNCH Ø 1.6 mm - Milled handle - Nickel plated



BO-100 BOUTEROLLE Ø 2,0 mm - Manche moleté - Nickelé
CUP PUNCH Ø 2.0 mm - Milled handle - Nickel plated

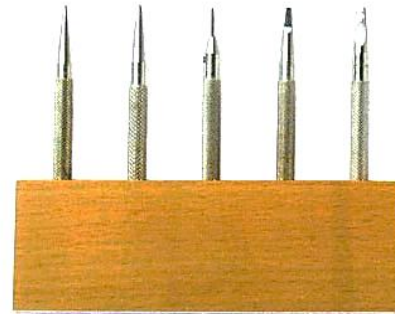

BO-091 ASSORTIMENT D'OUTILS DE CHOC
SUR SOCLE BOIS :
SET OF PUNCHING TOOLS ON WOOD STAND :

- 1 chasse goupille / Blunt punch (CH-038)
- 1 pointeau / Pointed punch (PO-080)
- 1 chasse goupille Ø 0,9 / Blunt punch Ø 0.9 (CH-039)
- 1 bouterolle Ø 1,6 / Cup punch Ø 1.6 (BO-099)
- 1 bouterolle Ø 2,0 / Cup punch Ø 2.0 (BO-100)



BO-101 BOUTEROLLE AUTOMATIQUE. Puissance de frappe réglable.
Pointes interchangeables. Livrée avec une pointe bouterolle
et une pointe pointeau
AUTOMATIC PUNCH. Adjustable power. Interchangeable points.
The punch is supplied with cup point and pointed point

BO-101/1 Pointe bouterolle de rechange
Replacement cup point

PO-101/1 Pointe pointeau de rechange
Replacement pointed point

Meulettes

Small wheels

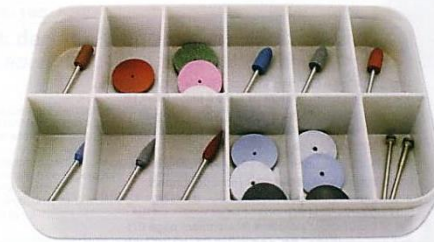

ME-102 ASSORTIMENT DE MEULETTES
comprenant :
SET OF SMALL WHEELS
including :

- 1 pc du **ME-080**
au **AX-111 (▲)**
- 1 pc from **ME-080**
to **AX-111 (▲)**

SACHET DE 2 PIÈCES PAR RÉFÉRENCE / BAG OF 2 PIECES PER TYPE



▲ **ME-080** Meulette
cylindrique en corindon Ø 7 mm
Cylindrical stone in corundum Ø 7 mm



Meulette disque en corindon Ø 22 mm
Disc stone in corundum Ø 22 mm
▲ **ME-081** Dur (rose) / Hard (pink)
▲ **ME-082** Moyen (vert) / Medium (green)
▲ **ME-083** Tendre (blanc) / Soft (white)



Cône caoutchouc Ø 6 mm
Rubber cone Ø 6 mm
▲ **ME-151** Gros (bleu) / Coarse (blue)
▲ **ME-152** Moyen (gris) / Medium (grey)
▲ **ME-153** Fin (brun) / Fine (brown)



Fiamme caoutchouc / Rubber flame
▲ **ME-161** Gros (bleu) / Coarse (blue)
▲ **ME-162** Moyen (gris) / Medium (grey)
▲ **ME-163** Fin (brun) / Fine (brown)



▲ **ME-090**
Disque caoutchouc
Ø 22 mm
Rubber disc Ø 22 mm



Disque silicone Ø 22 mm
Silicone disc Ø 22 mm
▲ **ME-111** Gros (blanc) / Coarse (white)
▲ **ME-112** Moyen (noir) / Medium (black)
▲ **ME-113** Fin (bleu) / Fine (blue)



Lentille silicone Ø 22 mm
Silicone knife edge Ø 22 mm
▲ **ME-121** Gros (blanc) / Coarse (white)
▲ **ME-122** Moyen (noir) / Medium (black)
▲ **ME-123** Fin (bleu) / Fine (blue)



▲ **AX-080** Axe / Mandrel
▲ **AX-111** Axe renforcé
Reinforced mandrel

Outils diamantés

Diamond tools

Disque / Disc
Sachet / Bag : 1 pc
Ø 20 x 0,5 : **FR-390/200**

Ronde / Round
Sachet / Bag : 1 pc
Ø 1,2 : **FR-381/012**
Ø 1,4 : **FR-381/014**
Ø 1,6 : **FR-381/016**

Flamme / Flame
Sachet / Bag : 1 pc
Ø 1,6 : **FR-382/016**
Ø 1,9 : **FR-382/018**



Disques en corindon

Corundum discs

Disque de tronçonnage / Cutting disc
Sachet / Bag : 10 pcs Ø 22 x 0,7 : **DI-950**
Montage sur perceuse
avec axe **AX-080** ou **AX-111**
Mounting on drill
with mandrel **AX-080** or **AX-111**



Outils et fournitures pour montage rimless

Tools and supplies for rimless mounting



FI-110

FIL NYLON - Diamètre 0,5 mm, cristal, en bobine de 20 mètres
RIMLESS REPLACEMENT CORD
Diameter 0.5 mm, crystal, in 20 meter spool

FI-107

FIL NYLON - Diamètre 0,6 mm, cristal, en bobine de 15 mètres
RIMLESS REPLACEMENT CORD
Diameter 0.6 mm, crystal, in 15 meter spool

FI-108

FIL NYLON - Diamètre 0,7 mm, cristal, en bobine de 15 mètres
RIMLESS REPLACEMENT CORD
Diameter 0.7 mm, crystal, in 15 meter spool

FI-109

FIL NYLON - Diamètre 1,0 mm, cristal, en bobine de 10 mètres
RIMLESS REPLACEMENT CORD
Diameter 1.0 mm, crystal, in 10 meter spool

FIL A DRAGEOIR, CRISTAL (section en 8)
pour partie supérieure des montages rimless,
(sachet de 4 m)
EYEWIRE REPLACEMENT CORD, CRYSTAL
(section in 8) for upper part of rimless mountings
(bag of 4 meters)

FI-120/4

d = 0,45 D = 0,55 H = 1,23

FI-125/4

d = 0,5 D = 0,62 H = 1,3

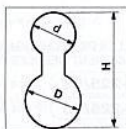

FI-121/4

FIL A DRAGEOIR, CRISTAL (section en T)
Sachet de 4 mètres
EYEWIRE REPLACEMENT CORD, CRYSTAL
(section in T)
Bag of 4 meters

FI-122/4

FIL A DRAGEOIR, CRISTAL (section en T,
petit modèle). Sachet de 4 mètres
EYEWIRE REPLACEMENT CORD, CRYSTAL
(section in T, small size)
Bag of 4 meters

LA-226/T

VERNIS DE RETOUCHE INCOLORE
Permet, après brossage, de supprimer l'aspect
mat de la tranche des verres meulés.
COLOURLESS RETOUCH VARNISH
For removing the dullness of the edge
of milled lenses after brushing.



FIL NYLON DE COULEUR - Diamètre 0,5 mm
en bobine de 15 mètres
COLOURED RIMLESS REPLACEMENT CORD - Diameter 0.5 mm
in 15 meter spool

-  **FI-111** Bleu Foncé / Dark Blue
-  **FI-112** Or / Golden rod
-  **FI-113** Noir / Black
-  **FI-114** Bleu Clair / Light Blue
-  **FI-115** Rouge Auburn / Scarlet
-  **FI-116** Brun Foncé / Dark Brown

FI-118 ASSORTIMENT DE FILS NYLON comprenant :

- SET OF NYLON CORDS including :
- 1 mètre de chacun des 6 fils nylon de couleur
 - 1 meter of each 6 coloured nylon cords

FI-119 ASSORTIMENT DE FILS NYLON comprenant :

- SET OF NYLON CORDS including :
- 6 bobines de fils nylon de couleur du FI-111 au FI-116
 - 6 spools of coloured nylon cords from FI-111 to FI-116

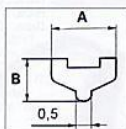

OU-110

OUTIL A MONTER LES FILS NYLON
RIMLESS MOUNTING TOOL

OU-110/1

CROCHETS DE RECHANGE
(sachet de 3 pcs)
REPLACEMENT HOOKS
(bag of 3 pcs)



TI-150

TIRE-FILS
pour montages nylon (sachet de 50 pcs)
PLASTIC STRIPS
for setting nylon thread in nylon mountings
(bag of 50 pcs)

Occlusion - Obturateurs - Press-on

Occlusion, Occluders and Press-on

Feuilles d'occlusion selon Bangertter Occlusion Foils according to Bangertter

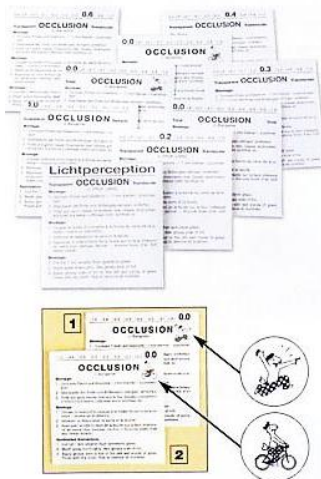

SACHET / BAG		Occlusion	Ancien N° Former Nr	Acuité visuelle avec feuille d'occlusion Keenness of sight with occlusion foils
1 Pc	3 Pcs			
FE-000/01	FE-000/03	0,0 (opaque)	8	0
FE-001/01	FE-001/03	Percept, lumin.	-	0
FE-005/01	FE-005/03	< 0,1	-	< 1/10
FE-010/01	FE-010/03	0,1	7	1/10
FE-020/01	FE-020/03	0,2	6	2/10
FE-030/01	FE-030/03	0,3	5	3/10
FE-040/01	FE-040/03	0,4	4	4/10
FE-060/01	FE-060/03	0,6	3	6/10
FE-080/01	FE-080/03	0,8	2	8/10
FE-100/01	FE-100/03	1,0 (transpar.)	1	10/10
FE-101		Assortiment de FE-000/01 à FE-100/01 (10 pcs) Set of FE-000/01 to FE-100/01 (10 pcs)		
FE-105/01	FE-105/03	0,0 (opaque)	Globi	
FE-106/01	FE-106/03	0,0 (opaque)	Globi velo/bike	

Press-on prismes et Press-on lentilles de 3 M 3M Press-on prisms and Press-on lens



PRESS-ON PRISMES (1 pc)
Utilisés pour traiter différents troubles de la mobilité oculaire, y compris le strabisme
PRESS-ON PRISMS (1 pc)
Used to treat several ocular mobility disorders, including strabismus

RÉFÉRENCE STOCK Nr	Valeur Value	RÉFÉRENCE STOCK Nr	Valeur Value
PR-100/01	1	PR-100/09	9
PR-100/02	2	PR-100/10	10
PR-100/03	3	PR-100/12	12
PR-100/04	4	PR-100/15	15
PR-100/05	5	PR-100/20	20
PR-100/06	6	PR-100/25	25
PR-100/07	7	PR-100/30	30
PR-100/08	8	-	-

PRESS-ON LENTILLES (1 pc). Utilisés pour certaines corrections de réfraction
PRESS-ON LENS (1 pc). Used for some refractive corrections

RÉFÉRENCE STOCK Nr	Valeur Value
PR-105/+03	+ 3

Obturateurs / Occluders



- OB-099** Obturateur avec 2 trous d'aération (24 mm). 1 pc.
Sucker occluder with 2 aeration holes (24 mm). 1 pc.
- OB-100** Obturateur avec 3 trous d'aération (30 mm). 1 pc.
Sucker occluder with 3 aeration holes (30 mm). 1 pc.
- OB-105** Obturateur 55 x 47 mm. 1 pc.
Sucker occluder 55 x 47 mm. 1 pc.

Péniches Job trays



Péniches Job trays

PENICHES
Dimensions : 240 x 167 x 49 mm. Sans séparations.
Grande résistance aux chocs. Cinq teintes mode.
Carton de 10 pièces d'une même couleur

JOB TRAYS
Size : 240 x 167 x 49 mm. Without inner partitions.
High resistance to shocks. Five fashionable colours.
Box with 10 pieces of a same colour

10 Pcs	Teintes / Colours
PE-240/10	Cristal / Crystal
PE-241/10	Orange / Orange
PE-242/10	Violet / Violet
PE-243/10	Bleu / Blue
PE-244/10	Fushia / Fushia

ET-211 ETIQUETTES pour PE-240 à PE-244
Dimensions : 69 x 22 mm. Sachet de 50 pièces
LABELS FOR PE-240 to PE-244
Size : 69 x 22 mm. Bag of 50 pieces

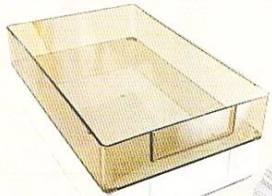

PENICHES
Dimensions : 260 x 166 x 45 mm. Sans séparations intérieures.
Carton de 20 pièces d'une même couleur

JOB TRAYS
Size : 260 x 166 x 45 mm. Without inner partitions.
Box with 20 pieces of a same colour

20 Pcs	Teintes / Colours
PE-230/20	Cristal / Crystal
PE-231/20	Fumé / Smoked

ET-215 ETIQUETTES pour PE-230 et PE-231
Dimensions : 80 x 26 mm. Sachet de 20 pièces
LABELS FOR PE-230 and PE-231
Size : 80 x 26 mm. Bag of 20 pieces

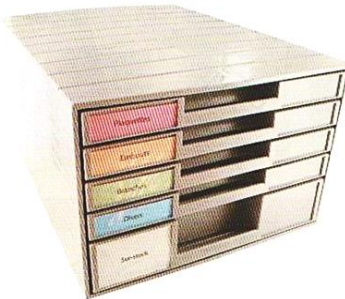

BO-120/V

Magic class box
Dimensions extérieures : 385 x 285 x 190 mm
Equippée de 5 tiroirs :
- 4 tiroirs, hauteur 30 mm
- 1 tiroir, hauteur 60 mm

Magic class box
Outer size : 385 x 285 x 190 mm
Fitted with 5 drawers :
- 4 drawers, height 30 mm
- 1 drawer, height 60 mm

Division intérieure des tiroirs / Inner partitions of drawers :

Tiroir 21 cases
Drawer 21 partitions

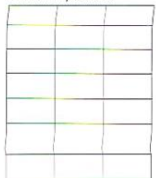

Tiroir 18 cases
Drawer 18 partitions



Tiroir 6 cases en long
Drawer 6 lengthwise partitions

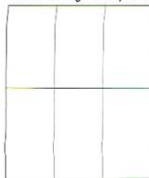

Tiroir sans division
Drawer without partitions

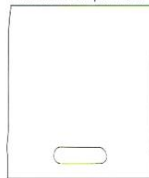

Tiroir sans division
Drawer without partitions



BO-110 BOITE RONDE POUR COMPOSANTS
12 cases, Ø 84 mm
SMALL PART HOLDER 12 partitions, Ø 84 mm

BO-112 BOITE RONDE POUR COMPOSANTS
20 cases, Ø 193 mm
LARGE HOLDER FOR SMALL PARTS
20 partitions, Ø 193 mm

BO-114 BOITE RECTANGULAIRE 12 cases,
210 x 90 x 20 mm
RECTANGULAR BOX 12 partitions,
210 x 90 x 20 mm

BO-115 BOITE RECTANGULAIRE 6 cases, 210 x 90 x 20 mm
RECTANGULAR BOX 6 partitions, 210 x 90 x 20 mm

BO-119 BOITE RECTANGULAIRE 4 cases en long, 210 x 90 x 20 mm
RECTANGULAR BOX 4 lengthwise partitions, 210 x 90 x 20 mm

BO-116 BOITE RECTANGULAIRE
12 cases, 190 x 110 x 35 mm
RECTANGULAR BOX
12 partitions, 190 x 110 x 35 mm

BO-117 BOITE RECTANGULAIRE
6 cases, 190 x 110 x 35 mm
RECTANGULAR BOX
6 partitions, 190 x 110 x 35 mm

BO-140 CASIER DE RANGEMENT
assemblable en hauteur et en largeur
Dimensions : 130 x 73 x 164,
équipé de 2 tiroirs de 124 x 33 x 160
STORAGE BOX combinable in height and width
Size : 130 x 73 x 164,
provided with 2 drawers, 124 x 33 x 160

BOÎTES-CLAP (bleues). Couverture transparente (Pc). Combinables
CLAP BOXES (blue). Transparent lid (Pc). Combinable

BO-130 Très petite / Very small
Dim. int. / Inside dim. : 37 x 12 x 15 mm

BO-131 Petite / Small
Dim. int. / Inside dim. : 37 x 40,5 x 15 mm

BO-132 Moyenne / Medium
Dim. int. / Inside dim. : 57 x 68 x 15 mm

BO-133 Grande / Large
Dim. int. / Inside dim. : 100 x 66 x 15 mm

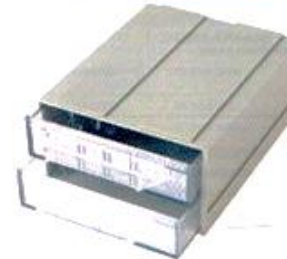

Mini Façonnage verres percés

Drilling Shaping of pierced lenses



Perceuse-Fraiseuse

Drilling and milling machine

Perceuse permettant le perçage et le fraisage du verre, du plastique et du métal. Le mandrin peut recevoir des forets et fraises avec un diamètre de tige de 0,5 à 6 mm. La vitesse de rotation est réglable sans palier grâce à un variateur de vitesse dans les plages suivantes : 500 à 1800 T/mn, 1250 à 4700 T/mn et 2295 à 8500 T/mn. Un blocage en hauteur permet de se mettre en situation de fraisage sans avoir à déplacer l'ensemble moteur.

L'ensemble est par ailleurs équipé d'une table croisée et d'un dispositif pour le perçage et le fraisage des verres. Ce dispositif monté sur la table croisée peut être déplacé rapidement latéralement et bloqué au niveau du travail à effectuer. Il reçoit les verres montés avec des blocs universels. Par ailleurs, il permet une double inclinaison pour se positionner exactement dans l'axe de courbure des verres : une inclinaison gauche-droite et une inclinaison avant-arrière.

Après avoir déplacé le dispositif dans la zone de travail, le réglage précis est effectué dans les deux axes à l'aide de la table croisée. Les fraisages (lumières ou encoches) sont également effectués à l'aide de la table croisée après blocage en hauteur de la tête de travail.

85 watts, 220/240 volts - Poids : 6,5 kg.

L'ensemble est composé :

D'une perceuse **PE-440/01**, d'une table croisée **TA-300** et d'un dispositif de perçage adapté au système de blocs universels (voir ci-dessous)

Outils de travail (non compris) : forets au carbure de tungstène **FO-608 - FO-620** (0,8 - 2,0 mm) (voir page 68).

Drilling machine enabling to pierce and mill glass, plastic and metal. The chuck can receive drill bits and cutters with a 0.5 to 6 mm shank diameter. The rotation speed is adjustable without level thanks to the speed variator in following ranges : 500 to 1800 rpm, 1250 to 4700 rpm and 2295 to 8500 rpm. A locking at the height enables to place oneself in a milling situation without having to move the motor set.

Besides, the set is equipped with a crossed table and a device for the drilling and the milling of lenses. This device mounted on the crossed table can be moved rapidly laterally and locked at the level of the work to make. It receives the mounted lenses with universal blocks. Moreover, it enables a double tilting to position itself exactly in the curve axis of lenses : a left-right tilting and a forward-backward tilting.

After having shifted the device in the work zone, the precised adjustment is made in both axes thanks to the crossed table. The millings (slots or notches) are also made with the crossed table after locking at the height of the work head.

85 watts, 220/240 volts, 6,5 kg

The equipment includes :

The drilling machine **PE-440/01**, the crossed table **TA-300** and one lens piercing device according to the appropriate block system (see below)

Working tools (not included) : tungsten carbide drill bits **FO-608 - FO-620** (0.8 - 2.0 mm) (see page 68).

Numéros d'ensemble suivant système de blocs universels :
Stock Nr of drilling and milling machine according to universal block system :

PE-440/51 pour / for Système Weco

PE-440/53 pour / for Système Essilor (Bleu / Blue)

PE-440/52 pour / for Système Hoya / Nidek / Indo

PE-440/55 pour / for Système Briot (Ancien / Old)

Dispositifs de perçage
Drilling systems

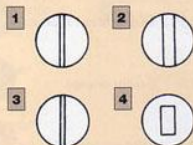

1 PE-440/61 pour / for Système Weco

2 PE-440/62 pour / for Système Hoya / Nidek / Indo

3 PE-440/63 pour / for Système Essilor (bleu / blue)

4 PE-440/65 pour / for Système Briot (ancien / old)

Façonnage verres percés

Shaping of pierced lenses

PE-185

Kit de façonnage verres percés

Shaping kit for pierced lenses

L'équipement permet de réaliser de façon précise l'ensemble des percages, lumières et/ou crans nécessaires aux montages type "verres percés".

Le dispositif permet une double inclinaison :

- inclinaison de la perceuse par basculement latéral de la colonne.
- inclinaison avant/arrière de la barre support de verres.

Ces deux basculements permettent de percer dans l'axe de courbure des verres ou avec l'inclinaison souhaitée.

Un système de butée intégré à la plaque support permet de réaliser des encoches. Un autre dispositif permet de faire des lumières.

L'équipement standard comprend :

- 1 **PE-186** - Support pour perceuse PE-131
- 1 **PE-189** - Barre inclinable support de verres
- 1 **PE-190** - Centreur Weeco (ou suivant choix à préciser *)
- 1 **PE-131** - Perceuse Vitesse 5 000 à 20 000 t/min avec mandrin universel, serrage de 0,5 à 3,2 mm
- 1 **PE-136** - Transformateur

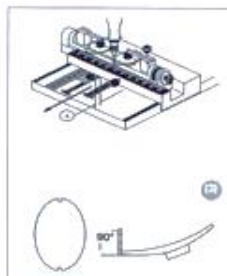
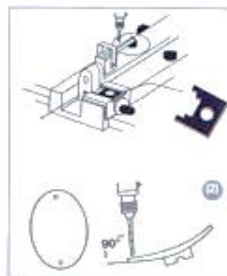
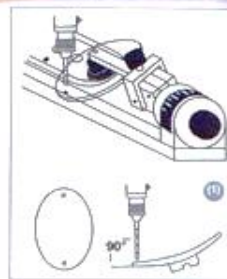

The equipment enables to make all the piercings, slots and/or notches necessary to the "pierced lenses" mountings in a precise way. The device allows a double tilting.

- tilting of the drilling machine by lateral rocking of the column.
- tilting forwards/backwards of the bar supporting lenses

Both tilings enable to pierce in the curvature axis of lenses or with the desired tilting.

A stop system integrated in the support plate enables to make notches. Another device enables to make slots.

The standard equipment includes :

- 1 **PE-186** - Support for PE-131 drilling machine
- 1 **PE-189** - Tiltable lens support bar
- 1 **PE-190** - Weeco centring device (or according to choice to be specified *)
- 1 **PE-131** - Drilling machine Speed : 5 000 to 20 000 rpm with universal chuck capacity 0.5 to 3.2 mm
- 1 **PE-136** - Power pack

* Centreurs

* Centring devices

PE-190 Weeco



PE-191 Nidek / Indo



PE-192 Essilor bleu / Blue



PE-193 Essilor orange



PE-194 Briot ancien / old



Mini perceuses et accessoires

Drilling machines and accessories



PE-117 KIT DE PERÇAGE comprenant : DRILLING KIT including :

- Mini perceuse à colonne. Vitesse 1 800/4 700/8 500 U/min.
Mandrin universel, serrage de 0,5 à 6 mm - **PE-116**
*Mini pedestal Drill. Speed 1 800/4 700/8 500 rpm.
Universal chuck capacity 0.5 to 6 mm.*
- Étau - **PE-115** / Vice
- Flexible avec mandrin - **PE-106** / Flexible with spindle
- Appui de perçage - **PE-128** / Piercing support
- Assortiment brossettes et polissoirs - **BR-102**
(voir contenu page 67)
Set of brushes and polishers (see content page 67)
- Assortiment forets - **FO-102** (voir contenu page 68)
Set of drill bits (see content page 68)

PE-150 KIT DE PERÇAGE comprenant : DRILLING KIT including :

- Perceuse avec variateur de vitesse, 5 000 à 20 000 U/min.
Mandrin universel, serrage 0,5 à 3,2 mm - **PE-131**
*Variable speed Drill 5 000 to 20 000 rpm universal chuck
capacity 0.5 to 3.2 mm*
- Transformateur - **PE-136** / Power pack
- Support de perceuse - **PE-141** / Drill stand
- Étau - Mors 50 mm - **PE-115** / Vice 50 mm jaws
- Appui de perçage - **PE-128** / Piercing support
- Assortiment brossettes et polissoirs - **BR-102**
(voir contenu page 67)
*Set of brushes and polishers
(see content page 67)*
- Assortiment forets - **FO-102**
(voir contenu page 68)
*Set of drill bits
(see content page 68)*



Dispositifs spécialisés (pour PE-150 et PE-117) Special devices (for PE-150 and PE-117)

PE-126

**DISPOSITIF DE PERÇAGE
AVEC VIS MICROMÉTRIQUE**
Au 1/100 de mm. Economique et d'une
installation simple et rapide
(sur **PE-116**, **PE-141** ou autre perceuse).
Ce dispositif permet d'assurer la précision
des perçages par rapport au bord du verre.

**DRILLING EQUIPMENT
WITH MICROMETRIC SCREW**
at 1/100 mm. Economical and with an
easy and speedy setting up
(on **PE-116**, **PE-141** or other drilling
machine). This equipment helps to ensure
the precision of drilling to the lens edge.

PE-126/1 Pointes de rechange (3 pcs)
Replacement tips (3 pcs)

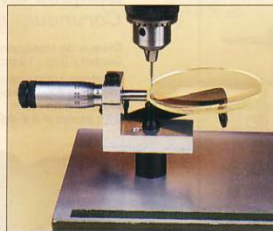

PE-128

APPUI DE PERÇAGE avec taseau nylon
PIERCING SUPPORT with nylon anvil

PO-102/14

Taseau nylon de rechange
Replacement nylon anvil



Fournitures diverses

Miscellaneous



HU-102

HUILEUR RECHARGEABLE (livré vide)
REFILLABLE OILER (delivered empty)



HU-104

HUILEUR NON RECHARGEABLE
NON REFILLABLE OILER



BR-050

BROSSE DURE (poils noirs)
pour le nettoyage des appareils, machines
et plans de travail
HAND BRUSH (hard hairs) for cleaning devices,
machines and working surfaces

GANTS blancs en microfibre (1 paire)
White microfiber GLOVES (1 pair)

GA-200/26 26 cm

GA-200/28 28 cm



HU-109

HUILE SPÉCIALE POUR HU-102
SPECIAL OIL FOR HU-102



DI-120

DISTRIBUTEUR DE LIQUIDE
(eau, alcool...)

LIQUID dispenser
(water, methylated spirit...)



LO-124

Loupe binoculaire avec 3 systèmes de lentilles
permettant d'obtenir 4 grossissements : 1,8 - 2,3 - 3,7 et 4,8
Binocular magnifier with 4 different diopters :
1.8 - 2.3 - 3.7 and 4.8.



LO-125

Loupe binoculaire éclairante avec 3 systèmes de lentilles
permettant d'obtenir 4 grossissements : 1,8 - 2,3 - 3,7 et 4,8
Livrée avec piles
Lighting binocular magnifier with 4 different diopters :
1.8 - 2.3 - 3.7 and 4.8. Supplied with battery

Fournitures diverses

Miscellaneous



Papiers de protection pour appui menton

Protective papers for chin support

PA-200

PAPIERS DE PROTECTION
pour appareils Humphrey, Zeiss...
100 x 36 mm. Entraxe : 78 mm.
Boîte de 1000 pièces
PROTECTIVE PAPERS
for Humphrey, Zeiss... machines
100 x 36 mm. Distance between holes : 78 mm.
Box of 1000 pieces



PA-201

PAPIERS DE PROTECTION
pour appareils Rodenstock
108 x 29 mm + arc de cercle. Entraxe : 93 mm.
Boîte de 1000 pièces
PROTECTIVE PAPERS
for Rodenstock machines
108 x 29 mm + arc of circle. Distance between holes : 93 mm.
Box of 1000 pieces



PA-202

PAPIERS DE PROTECTION
pour appareils Haag-Streit, Topcon, Nidek, Canon, Hoya
130 x 40 mm. Entraxe : 92,5 mm.
Boîte de 1000 pièces
PROTECTIVE PAPERS
for Haag-Streit, Topcon, Nidek, Canon, Hoya machines
130 x 40 mm. Distance between holes : 92.5 mm.
Box of 1000 pieces



PA-203

PAPIERS DE PROTECTION
pour appareils Zeiss-est
158 x 40 mm. Entraxe : 119 mm.
Boîte de 1000 pièces
PROTECTIVE PAPERS
for Zeiss-east machines
158 x 40 mm. Distance between holes : 119 mm.
Box of 1000 pieces

Papiers thermiques pour frontofocomètre automatique

Thermic papers for automatic lens meter

PA-220

PAPIER THERMIQUE
largeur 37 mm. Rouleau de 10 mètres
THERMIC PAPER
37 mm wide. Roll of 10 meters

PA-225

PAPIER THERMIQUE
largeur 57 mm. Rouleau de 25 mètres
THERMIC PAPER
57 mm wide. Roll of 25 meters



Fournitures

















Supplies

Pastilles autocollantes

Lens edging pads



Type / Type
Adhérence / Adherence

<p>PA-120</p>  <p>(500)* Ø 18</p>	<p>PA-110</p>  <p>(1000)* Ø 24</p>			<p>Standard Adhésif standard Standard Standard adhesive</p>
<p>PA-124</p>  <p>(1000)* Ø 18</p>	<p>PA-125</p>  <p>(1000)* Ø 24</p>	<p>PA-126</p>  <p>(500)* 18 x 24</p>	<p>PA-127</p>  <p>(1000)* 17 x 30</p>	<p>3M 411 Pour blocs souples Adhésif fort For soft blocks Strong adhesive</p>
<p>PA-140</p>  <p>(1000)* Ø 18</p>	<p>PA-141</p>  <p>(1000)* Ø 24</p>	<p>PA-139</p>  <p>(1000)* 21 x 14</p>	<p>PA-143</p>  <p>(1000)* 17 x 30</p>	<p>Pour blocs durs Adhésif très fort For hard blocks Very strong adhesive</p>
<p>PA-144</p>  <p>(1000)* Ø 18</p>	<p>PA-145</p>  <p>(1000)* Ø 24</p>			<p>Pour blocs durs Adhésif fort For hard blocks Strong adhesive</p>
<p>PA-105</p>  <p>(1000)* Ø 18</p>	<p>PA-106</p>  <p>(1000)* Ø 26</p>	<p>PA-107</p>  <p>(1000)* 24 x 24</p>	<p>PA-104</p>  <p>(1000)* 17 x 30</p>	<p>3M LEAP III Utilisation universelle Adhésif très fort Universal use Very strong adhesive</p>

* Quantité par rouleau / quantity per roll

Pastilles autocollantes
Lens edging pads

Fournitures
Supplies



Type / Type
Adhérence / Adherence

BluEdge™

Pour blocs souples
Forte adhérence
For soft blocks
Strong adherence

PA-151



(2000)*
Ø 24

PA-152



(2000)*
18 x 24

PA-153



(2000)*
17 x 30

BluEdge Hydro +

Pour blocs souples
Très forte adhérence
For soft blocks
Very strong adherence

PA-130



(1000)*
Ø 24

PA-133

Step Ellipse-Nano
(en deux parties)
(in two parts)



(1000)*
17 x 30

Films antitorsion pour verres traités
Films for coated lenses

Améliorent la tenue des pastilles autocollantes
For improving the holding of lens edging pads

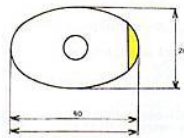

FI-153 Ovale / oval
(500)*

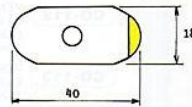

FI-154 Petite taille / small size
(500)*

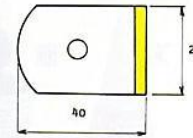

FI-155 Grande taille / large size
(500)*

* Quantité par rouleau / quantity per roll

Film de protection
(pastilles de diam. 30 mm)
Protection film (pad diam. 30 mm)



FI-150/C Sachet / Bag 100 pcs

FI-150/M Rouleau / Roll 1000 pcs



Distributeur de pastilles autocollantes
Lens edging pad dispenser

DI-900 DISTRIBUTEUR DE PASTILLES AUTOCOLLANTES
LENS EDGING PAD DISPENSER

- 1 **BO-299** BOUDIN (TUBE CAPILLAIRE)
Ø 0,8 mm x 15 mètres
TUBE Ø 0.8 mm x 15 meters
- 2 **BO-300** BOUDIN (TUBE CAPILLAIRE)
Ø 1,0 mm x 15 mètres
TUBE Ø 1.0 mm x 15 meters



- 3 **FI-105/12** FIL À DRAGEOIR (CYREX) EN PVC
en sachet (ép. 0,25 mm x 6 mètres), L = 1,2 mm
PVC LENS INTERLINER
in bag (th. 0.25 mm x 6 meters), L = 1.2 mm
- FI-105/16** FIL À DRAGEOIR (CYREX) EN PVC
en sachet (ép. 0,25 mm x 6 mètres), L = 1,6 mm
PVC LENS INTERLINER
in bag (th. 0.25 mm x 6 meters), L = 1.6 mm
- 4 **FI-103** FAUX DRAGEOIR AUTOCOLLANT
pour montures métalliques.
Lang. 1,6 mm x 16 mètres
"SELF STICK" LENS INTERLINER
for metal frames. Width 1.6 mm x 16 meters



- 5 **FI-101** FIL À DRAGEOIR (CYREX) EN ACETATE
fin (ép. 0,25 mm x 4,40 mètres)
ACETATE LENS INTERLINER (CYREX)
fine (th. 0.25 mm x 4.40 meters)
- 6 **FI-102** FIL À DRAGEOIR (CYREX) EN ACETATE
moyen (ép. 0,50 mm x 2,70 mètres)
ACETATE LENS INTERLINER (CYREX)
medium (th. 0.50 mm x 2.70 meters)



- 7 **FI-106** FIL À DRAGEOIR EN SILICONE
1,3 x 0,4 mm. Sachet de 4 m.
Son épaisseur et son élasticité permettent
d'absorber les points de tension
SILICONE LENS INTERLINER
1.3 x 0.4 mm. 4 m bag.
Its thickness and elasticity enable to avoid
strain points



- FI-104** FIL À DRAGEOIR EN SILICONE
1,6 x 0,6 mm. Sachet de 4 m
SILICONE LENS INTERLINER
1.6 x 0.6 mm. 4 m bag

- SI-101** SILICONE LIQUIDE. Grande fluidité.
Application précise par pointe aiguille.
Recommandé pour collage du polycarbonate.
En tube de 9 ml
LIQUID SILICONE CEMENT. High fluidity.
Precise application with needle point.
Advisable for gluing polycarbonate. In 9 ml tube



- SI-100** SILICONE TRANSPARENT. fluidité
moyenne. En tube de 82 ml
TRANSPARENT SILICONE SEALANT,
medium fluidity. In 82 ml tube



Pinces

Pliers

Description des gammes

Range description

B = Collection Best Best Range

Poignées larges aplaties 15 x 5 avec crans
fraîsés finition poli satiné. Mors (s'il y a lieu)
en matière plastique noire

Wide flattened handles 15 x 5 with milled
notches, glazed finishing. Jaws (if any) in
black plastic



C = Collection Confort Comfort Range

Poignées équipées de gaines-mousse
confortables et anti-glisse. Teinte bleu foncé.
Double ressort de rappel. Mors (s'il y a lieu)
en matière plastique blanche ou noire

Handles equipped with comfortable and anti-
slip foam rubber sleeves. Colour : dark blue.
Double return spring. Jaws (if any) in white
or black plastic



S = Collection Standard Standard Range

Poignées striées. Mors (s'il y a lieu)
en matière plastique blanche

Scratched handles.
Jaws (if any) in white plastic



Caractéristiques générales
(sauf indication contraire)
- acier inoxydable
- finition poli brillant
- assemblage par entrepassement (1)

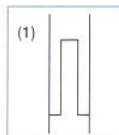

General features
(unless contrary indication)
- stainless steel
- bright finishing
- assembly by box joint (1)

Pinces spéciales Special pliers



PI-201/B PINCE À MODIFIER LES CERCLES
avec un mors nylon de 7 mm et un mors métal
Acier inoxydable - 145 mm - 110 g

PI-201/C *CIRCLE MODIFYING PLIER*
with one 7 mm nylon jaw and one metal jaw
Stainless steel - 145 mm - 110 g

PI-201/1 Mors de rechange
(1 pc + vis)
Replacement jaws
(1 pc + screw)

PI-204/B PINCE À TOURNER LES VERRES DEMI-LUNE
avec deux mors caoutchouc ovales 19 x 13 mm
Acier inoxydable - 150 mm - 130 g

PI-204/C *HALF FRAME LENS TURNING PLIER*
with two oval rubber jaws 19 x 13 mm
Stainless steel - 150 mm - 130 g

PI-204/1 Mors de rechange (1 paire)
Replacement jaws (1 pair)

PI-205/C PINCE À MENISQUER avec encoche de blocage
et deux mors nylon. Petit rayon env. 5,5 mm
Acier inoxydable - 145 mm - 100 g

*MENISCUS PLIER with blocking notch
and two nylon jaws. Small radius approx. 5.5 mm*
Stainless steel - 145 mm - 100 g

PI-205/1 Mors de rechange
(1 paire + vis)
Replacement jaws
(1 pair + screws)

PI-206/C PINCE À ENLEVER LES PLAQUETTES À CLIPPER
Acier inoxydable - 155 mm - 110 g

CLIP ON NOSE PAD REMOVING PLIER
Stainless steel - 155 mm - 110 g

PI-207/C PINCE D'ASSEMBLAGE / ASSEMBLY PLIER
Permet de rapprocher les cercles des montures
métalliques et de poser et visser les vis d'assem-
blage. La vis est introduite dans l'évidement de
l'un des mâchoires et serrée à l'aide d'un tourne-
vis à lame longue (TO-180/A20 ou TO-181/A20).
Acier inoxydable - 135 mm - 100 g

*Enables to bring circles of metal frames together
and to set and screw on assembly screws. The
screw is inserted in the hollow of one of the jaws
and screwed thanks to a long bladed screwdriver
(TO-180/A20 or TO-181/A20).*
Stainless steel - 135 mm - 100 g

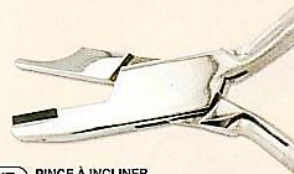

PI-200/B PINCE À INCLINER
Acier inoxydable - 140 mm - 120 g

INCLINATION PLIER
Stainless steel - 140 mm - 120 g

PI-200/1 Mors de rechange
(1 pc + vis)
Replacement jaws
(1 pc + screw)

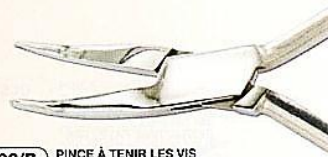

PI-202/B PINCE À TENIR LES VIS
becs courbes
Acier inoxydable - 150 mm - 100 g

SCREW HOLDING PLIER
bent noses
Stainless steel - 150 mm - 100 g

Montages type Silhouette Silhouette type mountings

PI-197/B PINCE DE MONTAGE avec 2 mors nylon fixes
Acier inoxydable - 145 mm - 105 g

PI-197/C MOUNTING PLIER with 2 fixed nylon jaws
Stainless steel - 145 mm - 105 g

PI-197/1 Mors de rechange (1 paire + vis) uniquement pour PI-197/C
Replacement jaws (1 pair + screws) only for PI-197/C

PI-197/1AM Mors ancien modèle pour PI-197/B et PI-197/C
Previous jaws for PI-197/B and PI-197/C

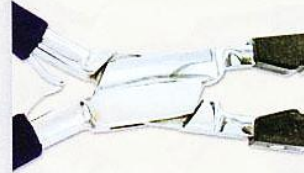

PI-198/C PINCE DE MONTAGE avec un mors fixe et un mors mobile
Acier inoxydable - 150 mm - 115 g

MOUNTING PLIER with one fixed jaw and one mobile jaw
Stainless steel - 150 mm - 115 g

PI-198/1 Mors de rechange (1 paire + vis)
Replacement jaws (1 pair + screws)

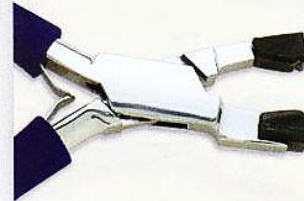

PI-213/B PINCE À DÉMONTER
Acier inoxydable - 155 mm - 120 g

PLIER FOR DISMOUNTING
Stainless steel - 155 mm - 120 g

PI-213/1 Mors de rechange (1 paire + vis)
Replacement jaws (1 pair + screws)



PI-216/B PINCE À EXTRAIRE avec deux crans dans les mâchoires pour démontage facile des cavaliers
Acier inoxydable - 140 mm - 110 g

EXTRACTING PLIER with two notches in the jaws for an easy disassembling of staple sockets
Stainless steel - 140 mm - 110 g



BR-298 BRUCELLES D'EXTRACTION des cavaliers
EXTRACTING TWEEZERS for staple sockets



Montages type Silhouette Silhouette type mountings



- TR-215** TROUSSE POUR MONTAGES ET DÉMONTAGES
type Silhouette comprenant :
- 3 pinces
- 1 gabarit de perçage (GA-140)
- 1 tube avec 25 cavaliers plastique (DO-110/25)
POUCH FOR MOUNTING AND DISMOUNTING
Silhouette type including :
- 3 pliers,
- 1 drilling template (GA-140),
- 1 tube with 25 plastic staple sockets (DO-110-25)

- PI-193/B** PINCE DE MONTAGE type Silhouette
MOUNTING PLIER Silhouette type
114 g - 150 mm

- PI-193/C** PINCE DE MONTAGE type Silhouette
MOUNTING PLIER Silhouette type
114 g - 150 mm

- PI-193/1** MORS DE RECHANGE (1 paire + vis)
pour PI-193/B et PI-193/C
REPLACEMENT JAWS (1 pair + screws)
for PI-193/B and PI-193/C

- PI-193/2** MORS AVEC RAINURE VERTICALE
(1 paire + vis)
JAWS WITH VERTICAL GROOVE
(1 pair + screws)



- PI-213/NB** PINCE DE DÉMONTAGE type Silhouette
DISMOUNTING PLIER Silhouette type
110 g - 150 mm

- PI-213/NC** PINCE DE DÉMONTAGE type Silhouette
DISMOUNTING PLIER Silhouette type
114 g - 150 mm

- PI-213/NC1** MORS DE RECHANGE (1 paire + vis)
pour PI-213/NB et PI-213/NC
REPLACEMENT JAWS (1 pair + screws)
for PI-213/NB and PI-213/NC

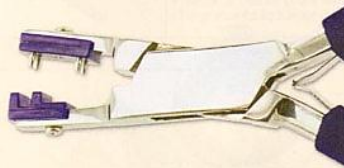

- PI-230** PINCE COUPANTE
Poignées équipées de gaines en plastique
Acier inoxydable - 71 g - 125 mm
CUTTING PLIER
with plastic sheathed handles
Stainless steel - 71 g - 125 mm

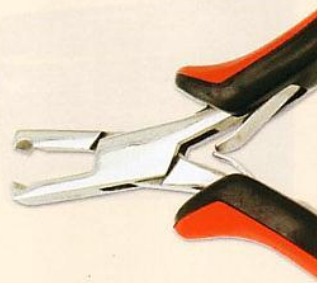

Pinces

Pliers

Collections
(voir / see page 2)

B = Best
C = Confort
S = Standard

Montages type Silhouette Silhouette type mountings

PI-199/B PINCE COUPANTE de face pour raccourcir les douilles cavalier en plastique
PI-199/C Acier inoxydable - 140 mm - 100 g
FRONT CUTTING PLIER for shortening plastic staple sockets
Stainless steel - 140 mm - 100 g

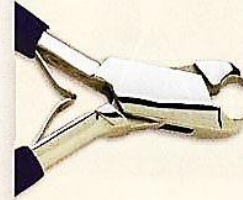

PI-215/E PINCE COUPANTE de face, droite, pour couper les cavaliers en plastique
Poignées plastifiées
Acier inoxydable - 115 mm - 65 g
STRAIGHT FRONT CUTTING PLIER for cutting plastic staple sockets
Plasticized handles
Stainless steel - 115 mm - 65 g



GA-140 GABARIT DE PERÇAGE
DRILLING TEMPLATE



AD-100 RUBAN ADHÉSIF double-face sans liner
Application facile et rapide. Pour fixation GA-140 (longueur 6,3 m, largeur 12 mm)
DOUBLE-FACED ADHESIVE without liner
Easy and quick application. For fixing GA-140 (Length 6.3 m, width 12 mm)



LI-147 ASSORTIMENT DE LIMES AIGUILLES
(voir page 20)
NEEDLE FILE SET
(see page 20)



Pinces Pliers

Collections
(voir / see page 2)

B = Best
C = Confort
S = Standard

Pinces d'utilisation générale : plates, demi-rondes et rondes Flat, half round and round nose pliers for all purposes



PI-171/B PINCE A BECS PLATS
Largeur de bec 3 mm
Acier inoxydable - 140 mm - 105 g
PI-171/S **FLAT NOSE PLIER**
3 mm wide jaws
Stainless steel - 140 mm - 105 g

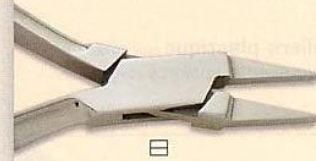

⊞



PI-178/B PINCE A LONGS BECS PLATS
Largeur de bec 3 mm
Acier inoxydable - 150 mm - 90 g
PI-178/S **LONG FLAT NOSE PLIER**
3 mm wide jaws
Stainless steel - 150 mm - 90 g



⊞



PI-118/S PINCE A BECS PLATS
Largeur de bec 5 mm
Acier inoxydable - 145 mm - 100 g
FLAT NOSE PLIER
5 mm wide jaws
Stainless steel - 145 mm - 100 g

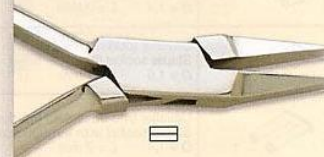

⊞

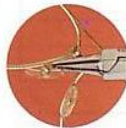

PI-108/B PINCE A CHAÎNE à becs effilés
Acier inoxydable - 140 mm - 90 g
PI-108/S **CHAIN NOSE PLIER**
with slim tapered jaws
Stainless steel - 140 mm - 90 g



⊖



PI-152/B PINCE A LONGS BECS DEMI-RONDS
Acier inoxydable - 150 mm - 90 g
PI-152/S **HALF ROUND LONG NOSE PLIER**
Stainless steel - 150 mm - 90 g

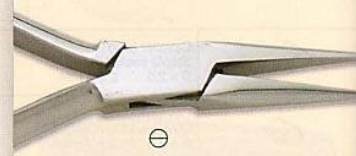

⊖

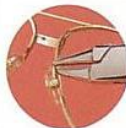

PI-112/B PINCE A LONGS BECS ROUNDS EFFILÉS
Acier inoxydable - 150 mm - 110 g
PI-112/S **LONG ROUND NOSE PLIER**
with fine tapered jaws
Stainless steel - 150 mm - 110 g

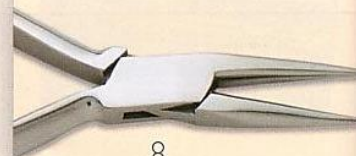

⊖

Pinces d'utilisation générale : plates, demi-rondes et rondes (suite)

Flat, half round and round nose pliers for all purposes (cont.)

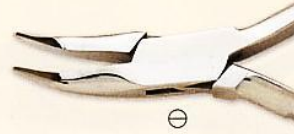

PI-189/B PINCE A BECS COURBES
Acier inoxydable - 135 mm - 100 g
BENT NOSE PLIER
Stainless steel - 135 mm - 100 g



Pinces à ajuster et à incliner

Adjustment and inclination pliers



PI-144/B PINCE A AJUSTER LES MONTAGES verres percés - Acier inoxydable - 148 mm - 120 g
PI-144/S **PLIER TO ADJUST PIERCED lens mountings**
Stainless steel - 148 mm - 120 g
Mors nylon de rechange (1 pc + vis)
Replacement nylon jaw (1 pc + screw)



PI-144/B1 Noir / Black
PI-144/1 Blanc / White



PI-161/B PINCE PLATE A TENIR avec 2 mors nylon largeur 7 mm
Acier inoxydable - 140 mm - 110 g
PI-161/S **FLAT HOLDING PLIER with two 7 mm wide nylon jaws - Stainless steel - 140 mm - 110 g**
Mors nylon de rechange (2 pcs + vis)
Replacement nylon jaw (2 pcs + screws)



PI-161/B1 Noir / Black
PI-161/1 Blanc / White



PI-117/B PINCE PLATE A TENIR avec 2 mors nylon largeur 11 mm, parallèles lorsque ouverte de 3 mm
Acier inoxydable - 140 mm - 110 g
PI-117/S **FLAT HOLDING PLIER with two 11 mm wide nylon jaws, parallel when 3 mm open**
Stainless steel - 140 mm - 110 g
Mors nylon de rechange (2 pcs + vis)
Replacement nylon jaws (2 pcs + screws)



PI-117/B1 Noir / Black
PI-117/1 Blanc / White

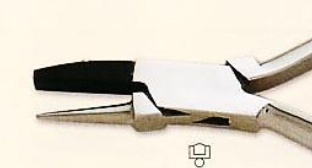

PI-130/B PINCE A INCLINER pour ajuster les bras de plaquettes, branches et tenons. Un mors nylon 7 mm, un mors rond métal
Acier inoxydable - 140 mm - 100 g
PI-130/S **INCLINATION PLIER for adjustment of pad arms, temples and end pieces. One 7 mm nylon jaw, one round metal jaw**
Stainless steel - 140 mm - 100 g
Mors nylon de rechange (1 pc + vis)
Replacement nylon jaw (1 pc + screw)



PI-130/B1 Noir / Black
PI-130/1 Blanc / White



PI-131/B PINCE A INCLINER avec 1 mors nylon demi-rond avec encoche évitant le glissement
Acier inoxydable - 140 mm - 100 g
PI-131/S **INCLINATION PLIER Half round nylon jaw with groove to prevent frame from slipping**
Stainless steel - 140 mm - 100 g
Mors nylon de rechange (1 pc + vis)
Replacement nylon jaw (1 pc + screw)



PI-131/B1 Noir / Black
PI-131/1 Blanc / White

Pinces

Pliers

Collections
(voir / see page 2)

B = Best
C = Comfort
S = Standard

Pinces à ajuster et à incliner (suite) Adjustment and inclination pliers (cont.)



PI-150/B PINCE A INCLINER pour ajuster branches et tenons. Un mors nylon de 11 mm, un mors métal en V

PI-150/S Acier inoxydable - 145 mm - 120 g
INCLINATION PLIER for adjustment of temples and end pieces.
One 11 mm nylon jaw + one metal jaw in V
Stainless steel - 145 mm - 120 g

Mors nylon de rechange (1 pc + vis)
Replacement nylon jaw (1 pc + screw)

PI-150/B1 Noir / Black

PI-150/1 Blanc / White



PI-190/B PINCE A INCLINER avec 1 mors nylon 7 mm et un mors métal cylindrique Ø 2,7

PI-190/S Acier inoxydable - 145 mm - 115 g
INCLINATION PLIER with one 7 mm nylon jaw and one cylindrical metal jaw Ø 2.7
Stainless steel - 145 mm - 115 g

Mors nylon de rechange (1 pc + vis)
Replacement nylon jaw (1 pc + screw)

PI-190/B1 Noir / Black

PI-190/1 Blanc / White



PI-107/B PINCE A TENONS avec trous dans la mâchoire permettant de bien maintenir la charnière

PI-107/S Acier inoxydable - 140 mm - 110 g

TEMPLE ANGLING PLIER
with holes in the jaw allowing to grip the hinges

Stainless steel - 140 mm - 110 g



PI-170/B PINCE A 3 POINTES becs ronds et lisses pour courber les bras de plaquettes

PI-170/S Acier inoxydable - 130 mm - 95 g

3-POINT PLIER
smooth round jaws for pad arm adjustment
Stainless steel - 130 mm - 95 g



PI-214/B PINCE À PLIER ET AJUSTER les attaches latérales en une opération

PLIER FOR FOLDING AND ADJUSTING
lateral fastenings in one operation
Stainless steel - 135 mm - 120 g



PI-179/S PINCE À AJUSTER LES CHARNIÈRES

Acier inoxydable - 135 mm - 100 g
HINGE ADJUSTMENT PLIER
Stainless steel - 135 mm - 100 g

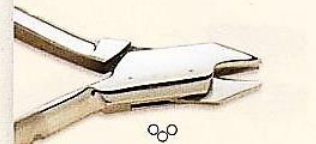

Pinces

Pliers

Pinces à ménisquer

Forming pliers



- PI-146/B** PINCE À MÉNISQUER - 1 mors nylon largeur 18 mm + 1 mors nylon largeur 7 mm
Acier inoxydable - 145 mm - 125 g
- PI-146/S** NYLON EYEWIRE FORMING PLIER
One 18 mm wide nylon jaw + one 7 mm wide nylon jaw - Stainless steel - 145 mm - 125 g
Mors nylon de rechange (1 paire + vis)
Remplacement nylon jaw (1 pair + screws)

PI-146/B1 Noir / Black

PI-146/1 Blanc / White



- PI-176/B** PINCE À MÉNISQUER
mors nylon largeur 18 mm
Acier inoxydable - 145 mm - 110 g
- PI-176/S** NYLON EYEWIRE FORMING PLIER
18 mm wide nylon jaws
Stainless steel - 145 mm - 110 g
Mors nylon de rechange (1 paire + vis)
Remplacement nylon jaw (1 pair + screws)

PI-176/B1 Noir / Black

PI-176/1 Blanc / White



- PI-133/B** PINCE À MÉNISQUER mors nylon largeur 24 mm - Acier inoxydable - 140 mm - 125 g
- PI-133/S** NYLON EYEWIRE FORMING PLIER
24 mm wide nylon jaws
Stainless steel - 140 mm - 125 g
Mors nylon de rechange (1 paire + vis)
Remplacement nylon jaw (1 pair + screws)

PI-133/B1 Noir / Black

PI-133/1 Blanc / White

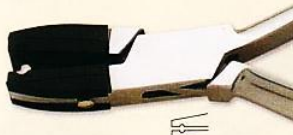

- PI-132/B** PINCE À MÉNISQUER ET COURBER
4 mors nylon pour l'ajustage des ponts, embouts et branches (largeur 12 mm)
Acier inoxydable - 140 mm - 110 g
- PI-132/S** MENISCUS AND BENDING PLIER
with nylon jaws for adjusting metal bridges, temple tips and temples (12 mm wide jaws)
Stainless steel - 140 mm - 110 g
Mors nylon de rechange (1 paire + vis)
Remplacement nylon jaw (1 pair + screws)

PI-132/B1 Noir / Black

PI-132/1 Blanc / White



Pinces spéciales

Special purpose pliers

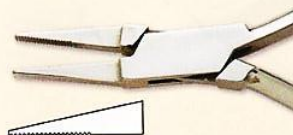

- PI-203/S** PINCE À EXTRAIRE plate, largeur 3 mm avec intérieur des mâchoires strié. Standard.
Acier inoxydable - 145 mm - 90 g
EXTRACTING PLIER flat, 3 mm wide, with scratched inside of jaws.
Standard.
Stainless steel - 145 mm - 90 g



- PI-225/B** PINCE À TENIR à mâchoires percées.
Permet de tenir au niveau de la vis d'assemblage branche/tenon. Acier inoxydable - 140 mm - 75 g
HOLDING PLIER with pierced jaws for holding at the level of the temple/lug assembly screw
Stainless steel - 140 mm - 75 g

Pinces spéciales [suite]

Special purpose pliers [cont.]



PI-164/B
PI-164/S

PINCE À ENLEVER LES BLOCS UNIVERSELS WECO
Intérieur des mâchoires lisse pour blocs en matière plastique
Acier inoxydable - 150 mm - 130 g
WECO UNIVERSAL BLOCK REMOVING PLIER
Polished jaw insides for blocks in plastic
Stainless steel - 150 mm - 130 g



PI-120/S

PINCE À ENLEVER LES VENTOUSES INDO-HOYA-NIDEK
Acier inoxydable - 150 mm - 110 g
INDO-HOYA-NIDEK SUCKER REMOVING PLIER
Stainless steel - 150 mm - 110 g



PI-195/B
PI-195/S

PINCE À ENLEVER LES VENTOUSES et blocs universels (modèle frontal). Intérieur des mâchoires strié.
Dimension int. fermé = 14 mm
Pour ventouses et blocs avec talon diamètre 16 mm (Essilor - Weco)
Acier inoxydable - 145 mm - 110 g
SUCKER AND BLOCK REMOVING PLIER
Inner size closed = 14 mm
(frontal) for suckers and universal blocks with heel - 16 mm diameter (Essilor - Weco)
Stainless steel - 145 mm - 110 g



PI-226/E

PINCE LATÉRALE à enlever les blocs Briot
Poignées plastifiées - Acier inoxydable
155 mm - 180 g
SIDE PLIER for removing Briot blocks
Plasticized handles - Stainless steel
155 mm - 180 g

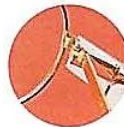
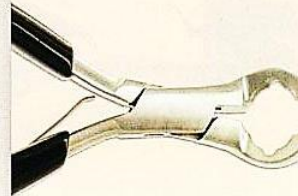

PI-175/B
PI-175/S

PINCE À RAPPROCHER permettant de vérifier la taille du verre dans la monture
Acier inoxydable - 140 mm - 100 g
CLOSURE PLIER
for testing the lens form
Stainless steel - 140 mm - 100 g

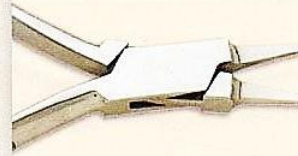

PI-185/S

PINCE À INSÉRER LES FILS NYLON
Acier inoxydable - 140 mm - 105 g
NYLON CORD COMPRESSING PLIER
Stainless steel - 140 mm - 105 g



Pinces spéciales (suite)
Special purpose pliers (cont.)

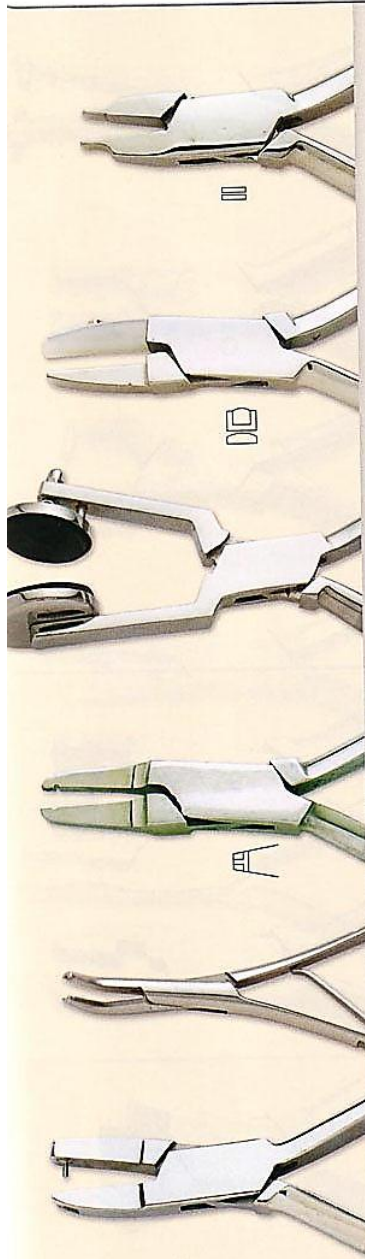

PI-182/S

**PINCE À AJUSTER LES CHARNONS
DES CHARNIÈRES**
Acier inoxydable - 140 mm - 120 g
HINGE LOOP SETTING PLIER
Stainless steel - 140 mm - 120 g



PI-194/S

PINCE À RHABILITER
un mors plat nylon et un mors métal convexe
Acier inoxydable - 140 mm - 110 g
HOLLOW DROP PLIER
One flat nylon jaw and one convex metal jaw
Stainless steel - 140 mm - 110 g



PI-130/1

Mors nylon de rechange
(1 pc + vis)
Replacement nylon jaw
(1 pc + screw)

PI-106/B

PINCE À TOURNER LES VERRES (classique)
1 mors fixe Ø 32 + 1 mors mobile Ø 26
Acier inoxydable - 205 mm - 220 g
LENS AXIS PLIER (classical)
1 fixed jaw Ø 32 + 1 mobile jaw Ø 26
Stainless steel - 205 mm - 220 g



PI-106/5

Mors de rechange (1 paire)
Replacement jaws (1 pair)

PI-109/B

PINCE À TOURNER LES VERRES (demi-lunes)
1 mors fixe Ø 23 + 1 mors mobile Ø 18
Acier inoxydable - 200 mm - 210 g
LENS AXIS PLIER (half frame)
1 fixed jaw Ø 23 + 1 mobile jaw Ø 18
Stainless steel - 200 mm - 210 g

PI-109/5

Mors de rechange (1 paire)
Replacement jaws (1 pair)

PI-111/S

PINCE À TENIR LES VIS
Acier inoxydable - 140 mm - 105 g
SCREW HOLDING PLIER
Stainless steel - 140 mm - 105 g



PI-209/B

PINCE AVEC BLOCAGE pour tenir les vis
Acier inoxydable - 140 mm - 35 g
PLIER WITH LOCKING for holding screws
Stainless steel - 140 mm - 35 g

PI-218/B

PINCE À CHASSER LES VIS ET LES RIVETS
Acier inoxydable - 145 mm - 115 g
PLIER FOR DRIVING OUT SCREWS AND RIVETS
Stainless steel - 145 mm - 115 g

Pinces

Pliers

Collections
(voir / see page 2)

B = Best
C = Confort
S = Standard

Pinces à pointer

Flaring pliers



PI-186/B PINCE A POINTER à pointeau réglable
Acier inoxydable - 145 mm - 120 g

PI-186/S FLARING PLIER with adjustable pin
Stainless steel - 145 mm - 120 g

PI-186/1 Pointe de rechange (1 pc)
Replacement pin (1 pc)



PI-113/S PINCE A POINTER les vis et les rivets
Acier inoxydable - 135 mm - 95 g
PLIER for flaring screws and rivets
Stainless steel - 135 mm - 95 g



PI-172/B PINCE A POINTER mâchoires profondes
Acier inoxydable - 135 mm - 105 g

PI-172/S FLARING PLIER wide jaws
Stainless steel - 135 mm - 105 g

PI-172/1 Pointe de rechange (1 pc)
Replacement pin (1 pc)



Pinces à égruger

Glass chipping pliers



PI-116/B PINCE A ÉGRUGER
avec mors interchangeable
Acier inoxydable - 135 mm - 120 g

PI-116/S GLASS CHIPPING PLIER
with interchangeable jaws
Stainless steel - 135 mm - 120 g

PI-116/1 Mors de rechange
(1 paire + vis)
Replacement jaws
(1 pair + screws)



PI-167/S PINCE A ÉGRUGER
largeur 8 mm
140 mm - 120 g

GLASS CHIPPING PLIER
8 mm wide jaws
140 mm - 120 g



PI-168/S PINCE A ÉGRUGER
largeur 30 mm
150 mm - 160 g

GLASS CHIPPING PLIER
30 mm wide jaws
150 mm - 160 g



Pinces à ajuster les plaquettes de nez

Nose pad adjusting pliers



- PI-102/B** PINCE À PLAQUETTES à becs fins et longs
Acier inoxydable - 145 mm - 100 g
- PI-102/S** LONG NOSE PAD ADJUSTING PLIER
Stainless steel - 145 mm - 100 g



- PI-103/B** PINCE À AJUSTER LES PLAQUETTES à visser
Acier inoxydable - 140 mm - 90 g
- PI-103/S** PLIER FOR ADJUSTING screw-on nose pads
Stainless steel - 140 mm - 90 g



- PI-192/B** PINCE A PLAQUETTES A BECS FINS
Acier inoxydable - 135 mm - 100 g
- PI-192/S** PAD ADJUSTING PLIER EXTRA NARROW JAWS
Stainless steel - 135 mm - 100 g



- PI-196/B** PINCE A PLAQUETTES avec un mors nylon (Spécial pour plaquettes silicone)
Acier inoxydable - 140 mm - 110 g
- PI-196/S** PAD ADJUSTING PLIER with one nylon jaw (Especially useful for soft silicone pads)
Stainless steel - 140 mm - 110 g
- Mors nylon de rechange (1 pc)
Replacement nylon jaw (1 pc)
- PI-196/B1** Noir / Black
- PI-196/1** Blanc / White

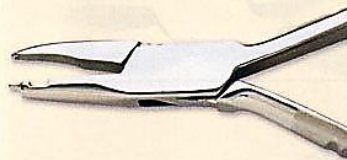

- PI-221/B** PINCE A PLAQUETTES avec pointe pour réglage des bras de plaquettes
Acier inoxydable - 150 mm - 115 g
- NOSE PAD PLIER**
with pin for adjusting pad arms
Stainless steel - 150 mm - 115 g

Pince à tenir les montures

Wire gripping pliers



- PI-137/S** PINCE A TENIR LES PONTS ET MONTURES MÉTALLIQUES
Acier inoxydable - 115 mm - 75 g
- WIRE GRIPPING PLIER**
Stainless steel - 115 mm - 75 g



Pinces coupantes Cutting pliers

PI-104/B

PINCE COUPANTE DE FACE
moitié avec biseau, moitié sans biseau.
Capacité de coupe : côté biseauté = métaux
doux jusqu'à Ø 1,4 mm. Côté plat = métaux
doux jusqu'à Ø 1 mm.
120 mm - 90 g

FRONT CUTTING PLIER
Half V cut, half flat. Cutting capacity :
V cut side = soft metals up to 1.4 mm Ø.
Flat side = soft metals up to 1 mm Ø.
120 mm - 90 g

PI-187



PI-187/B

PINCE COUPANTE DE FACE
avec vis de blocage pour régler l'ouverture
des mâchoires. Permet d'éviter de transmettre
l'effet de choc au verre lors de la coupe
d'une vis. 130 mm - 130 g

FRONT CUTTING PLIER
with screw lock to adjust the jaw opening
for avoiding the transmission of the
shock effect to the lens during the cutting
of a screw. 130 mm - 130 g

PI-184/B

PINCE COUPANTE DE FACE
Idem à PI-187 mais sans vis de blocage
130 mm - 105 g

PI-184/S

FRONT CUTTING PLIER
Same as PI-187 but without screw lock
130 mm - 105 g



PI-184

PI-105/B

PINCE COUPANTE LATÉRALE
entrepassée. Avec biseau.

PI-105/S

Capacité de coupe :
métaux mi-durs jusqu'à Ø 1,5 mm
140 mm - 125 g

SIDE CUTTING PLIER
box jointed. V cut. Cutting capacity :
half hard metals up to 1.5 mm Ø
140 mm - 125 g



PI-140/B

PINCE COUPANTE DIAGONALE
avec biseau. Capacité de coupe :
métaux mi-durs jusqu'à Ø 1,2 mm
140 mm - 120 g

DIAGONAL CUTTING PLIER
V cut. Cutting capacity :
half hard metals up to 1.2 mm Ø
140 mm - 120 g

PI-151/E

PINCE COUPANTE DIAGONALE
avec biseau. Capacité de coupe :
métaux mi-durs jusqu'à Ø 1,2 mm
Poignées plastifiées
120 mm - 70 g

DIAGONAL CUTTING PLIER
V cut. Cutting capacity :
half hard metals up to 1.2 mm Ø
Plasticized handles
120 mm - 70 g

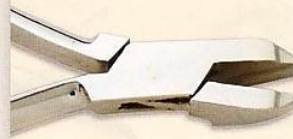

Pinces Pliers

Pinces coupantes (suite) Cutting pliers (cont.)



PINCE COUPANTE LATÉRALE SUPERPOSÉE
avec grande capacité de coupe (voir tableau ci-dessous)
en acier au chrome vanadium. Trempée à l'huile.
Dureté des tranchants environ 64 HRC. Polie.
Poignées plastifiées PVC

SIDE CUTTING PLIERS SUPERPOSED
with large cutting capacity (see below board)
in vanadium chrome steel. Oil hardened.
Hardness of cutting edges about 64 HRC. Polished.
PVC plasticized handles.

PI-210/E = 140 mm / 130 g

PI-211/E = 160 mm / 170 g



PI-212/E **PINCE COUPANTE DE FACE** avec grande capacité de coupe
en acier au chrome vanadium. Trempée à l'huile.
Dureté des tranchants 63 HRC. Polie.
Poignées plastifiées PVC. 140 mm / 150 g

FRONT CUTTING PLIER with large cutting capacity
in vanadium chromo steel. Oil hardened.
Hardness of cutting edges 63 HRC. Polished.
PVC plasticized handles.
140 mm / 150 g

CAPACITÉ DE COUPE (Ø fil en mm)
CUTTING CAPACITY (Ø of thread in mm)

	PI-210/E	PI-211/E	PI-212/E
Acier doux - Maillechort Soft steel - Nickel silver	3,1	3,4	3,1
Acier dur - Inox Hard steel - Stainless steel	2,0	2,5	2,0
Corde à piano Piano string	1,5	2,0	1,5



PI-139/E **PINCE COUPANTE LATÉRALE**
Superposée, poignées équipées de gaines
en plastique, ressort de rappel.
Capacité de coupe : vis inox jusqu'au diamètre 1,6 mm
Acier au carbone - 135 mm - 90 g

SIDE CUTTING PLIER
Superposed, with plastic sheathed handles
and return spring.
Cutting capacity : stainless steel screws up to 1.6 mm diameter
Carbon steel - 135 mm - 90 g

Coupe-vis Screw cutters



CO-550 **COUPE-VIS**
permet de couper les vis maillechort de
M 1,2 à M 1,5
Acier inoxydable - 100 mm - 40 g

SCREW CUTTER
Enables to cut nickel silver screws from
M 1.2 to M 1.5
Stainless steel - 100 mm - 40 g



CO-552 **COUPE-VIS**
Acier inoxydable - 130 mm - 90 g

SCREW CUTTER
Stainless steel - 130 mm - 90 g



Pinces Pliers

Collections
(voir / see page 2)

B = Best
C = Confort
S = Standard

Pinces à marquer (sur branches ou verres organiques) Marking pliers (on temples or organic lenses)



◀ Marquage sur verre organique
Marking on organic lens

◀ Marquage sur branche
Marking on temples

PI-191/S

PINCE A MARQUER (sans le poinçon)
Acier inoxydable - 130 mm - 225 g
MARKING PLIER (without punch)
Stainless steel - 130 mm - 225 g

PI-191/01 à **PI-191/06**

Poinçon. Prix variable en fonction du nombre de caractères ou signes.
6 caractères (ou signes) maximum (si hauteur 1 mm).

Ex. : 2 caractères → réf. : PI-191/02

Punch. Price changing according to the number of characters or signs. 6 characters (or signs) maximum (if 1.0 mm high).
Ex. : 2 characters → ref. : PI-191/02

PI-191/CE Poinçon CE / Punch CE



Pince montée avec poinçon
Plier mounted with punch

Gaines plastique pour poignées de pinces (pour type S seulement / for S type only) (sachet de 5 paires) Plastic sleeves for plier handles (bag of 5 pairs)

Adaptables sur la plupart des pinces, en remplacement de gaines détériorées ou en équipement de poignées non gainées. Pour le confort ou pour faciliter l'identification (différencier les pinces ou les utilisateurs).

Adaptable on most plier handles, to replace damaged sleeves or equip non sleeved pliers. For comfort or for an easier identification (to distinguish pliers or users).



Exemples de gaines plastique montées
Examples of mounted plastic sleeves

PI-250/05

Bleu foncé
Dark blue

PI-255/05

Rouge
Red

PI-260/05

Jaune
Yellow

PI-265/05

Bleu clair
Light blue

PI-270/05

Vert
Green

Pince à clamper - Ciseaux - Scalpel Clamping plier - Scissors - Scalpel

Ciseaux
Scissors



CI-140

CISEAUX MULTI-USAGE
MULTIPLE USE SCISSORS



CI-110

CISEAUX 150 mm en acier inoxydable
SCISSORS 150 mm in stainless steel

Pince à clamper
Clamping plier



PI-240

PINCE A CLAMPER
(maintien avec blocage)
Acier inoxydable 140 mm - 33 g
CLAMPING PLIER
(holding with locking)
Stainless steel - 140 mm - 33 g

Scalpel / Scalpel



Capuchon / Cap

SC-100/1

SCALPEL métal (1pc)
Metal SCALPEL (1 pc)

SC-101/3

LAMES DE RECHANGE pour SC-100/1 (3 pcs)
REPLACEMENT BLADES for SC-100/1 (3 pcs)

Plaquettes - Nez - Supports

Nose pads - Saddle bridges - Nose pad arms

Nez en silicone (3 pièces) / Silicone saddle bridges (3 pieces)

	A	B	C	D	E	Insert Palladium	Insert doré / Gold	
Monture métal / Metal frame								
Petit / Small	14,9	11,5	6,0	2,5	25,0	NE-201/3	NE-201/D3	
Grand / Large	16,9	13,5	6,0	2,5	25,0	NE-202/3	NE-202/D3	
Enfants / Kids	17,3	14,5	6,0	2,5	21,0	NE-203/3	—	
Monture plastique / Plastic frame								
Petit / Small	14,9	11,5	6,0	0,7	25,0	—	NE-210/D3	
"Harmony"	18,0	—	6,0	—	8,0	NE-212/3	NE-212/D3	
Baby						(Insert Polycarbonate / Polycarbonate insert)		
Petit / Small	16,5	—	—	—	15,0	NE-198/3	NE-198/3	
Grand / Large	16,5	—	—	—	19,0	NE-199/3	NE-199/3	
Accessoires de montage / Assembly sets (quantité pour le montage de 3 pcs / quantity for mounting 3 pcs)								
Pour métal / For metal						NE-209/3	NE-209/D3	
Pour plastique / For plastic						—	NE-219/D3	
Pour Harmony / For Harmony						NE-208/3	—	

Nez en acétate (3 pièces) Acetate saddle bridges (3 pieces)

NE-225/3 Nez à clipper
Push-on saddle bridge

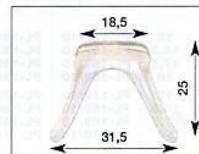

Supports de plaquettes de nez Nose pad arms



CASE	RÉFÉRENCE STOCK N°	QUANT. PR
1	SU-100	5
2	SU-104	5
3	SU-101	5
4	SU-105	5
5	SU-102	5
6	SU-106	5
7	SU-110	5
8	SU-114	5
9	SU-111	5
10	SU-115	5
11	SU-112	5
12	SU-116	5

SU-090

ASSORTIMENT DE SUPPORTS pour plaquettes à visser et plaquettes à clipper, comprenant :
SET OF ARMS for screw-on nose pads and push-on nose pads, including :

• Voir tableau ci-dessus
See above board

Type Type	RÉFÉRENCE / STOCK N°		
	Sachet de 5 paires / Bag of 5 pairs		
	Nickelé / Nickel plated	Doré / Gold	
• Supports pour plaquettes à visser Arms for screw-on nose pads	1	SU-100/5	SU-104/5
	2	SU-101/5	SU-105/5
	3	SU-102/5	SU-106/5
• Supports pour plaquettes à clipper Arms for push-on nose pads	4	SU-110/5	SU-114/5
	5	SU-111/5	SU-115/5
	6	SU-112/5	SU-116/5
• Supports pour plaquettes monobloc Arms for solid nose pads	7	SU-141/5	SU-141/D5
• Supports Primadonna Primadonna Arms	8	SU-128/5	SU-128/D5



Plaquettes à clipper

Push-on nose pads



● Plaquettes silicone Silicone nose pads

• Plaquettes asymétriques Asymmetrical nose pads

Taille Size mm	10 paires 10 pairs	20 paires 20 pairs	100 paires 100 pairs
15	PL-179/10	PL-179/20	PL-179/C
17	PL-180/10	PL-180/20	PL-180/C
19	PL-181/10	PL-181/20	PL-181/C



• Plaquettes symétriques Symmetrical nose pads

9	PL-182/10	PL-182/20	PL-182/C
11	—	PL-186/20	PL-186/C
13	PL-178/10	PL-178/20	PL-178/C
15	PL-285/10	PL-285/20	PL-285/C
17	PL-286/10	PL-286/20	PL-286/C
19	PL-287/10	PL-287/20	PL-287/C



13	PL-279/10	PL-279/20	PL-279/C
16	PL-280/10	PL-280/20	PL-280/C
19	PL-281/10	PL-281/20	PL-281/C



● Plaquettes souples en PVC Soft PVC nose pads

Inserts métalliques Metal inserts

• Plaquettes asymétriques Asymmetrical nose pads

inserts nickelés
nickel inserts

Taille Size mm	10 paires 10 pairs	20 paires 20 pairs	100 paires 100 pairs
12	PL-162/10	PL-162/20	PL-162/C
14,3	PL-157/10	PL-157/20	PL-157/C
17,5	PL-159/10	PL-159/20	PL-159/C
19	PL-160/10	PL-160/20	PL-160/C
12	PL-172/10	PL-172/20	PL-172/C
14,3	PL-168/10	PL-168/20	PL-168/C
17,5	PL-169/10	PL-169/20	PL-169/C
19	PL-170/10	PL-170/20	PL-170/C



inserts dorés
gold inserts

• Plaquettes symétriques Symmetrical nose pads

inserts nickelés
nickel inserts

12	PL-386/10	PL-386/20	PL-386/C
15	PL-387/10	PL-387/20	PL-387/C
17,2	PL-388/10	PL-388/20	PL-388/C
12	PL-389/10	PL-389/20	PL-389/C
15	PL-390/10	PL-390/20	PL-390/C
17,2	PL-391/10	PL-391/20	PL-391/C



inserts dorés
gold inserts

Inserts en polycarbonate Polycarbonate inserts

• Plaquettes asymétriques Asymmetrical nose pads

Taille Size mm	10 paires 10 pairs	20 paires 20 pairs	100 paires 100 pairs
15	PL-240/10	PL-240/20	PL-240/C
17	PL-241/10	PL-241/20	PL-241/C
19	PL-242/10	PL-242/20	PL-242/C



• Plaquettes symétriques Symmetrical nose pads

9	PL-238/10	PL-238/20	PL-238/C
13	PL-239/10	PL-239/20	PL-239/C
12	PL-393/10	PL-393/20	PL-393/C
15	PL-394/10	PL-394/20	PL-394/C
17	PL-395/10	PL-395/20	PL-395/C



Plaquettes à clipper

Push-on nose pads

● Plaquettes dures en acétate

Hard acetate nose pads

Taille Size mm	10 paires 10 pairs	20 paires 20 pairs	100 paires 100 pairs
17,5	PL-080/10	PL-080/20	PL-080/C
17,5	PL-085/10	PL-085/20	PL-085/C

Asymétriques
Asymmetrical

◀ inserts nickelés / nickel inserts

◀ inserts dorés / gold inserts

● Plaquettes ultra-fines monobloc

Solid ultra-thin pads

Taille Size mm	10 Paires/pairs	20 Paires/pairs	100 Paires/pairs
10	PL-234/10	PL-234/20	PL-234/C
12	PL-235/10	PL-235/20	PL-235/C
14	PL-236/10	PL-236/20	PL-236/C
1	12	PL-232/10	PL-232/20
	14	PL-230/10	PL-230/20
2	12	PL-232/10	PL-232/20
	14	PL-230/10	PL-230/20

◀ Plaquettes ultra-fines épaisseur 1 mm
en matière dure, hypoallergénique
Ultra-thin nose pads, thickness : 1 mm
in hard material, hypoallergenic

◀ Plaquettes ultra-fines souples
Soft ultra-thin nose pads

● Plaquettes jumelées

Saddle pads

Taille Size mm	5 pcs	20 pcs
23,3	PL-183/05	PL-183/20
30,5	PL-184/05	PL-184/20
36,8	PL-185/05	PL-185/20
36	PL-176/05	PL-176/20
32	PL-175/05	PL-175/20
23,3	PL-259/05	PL-259/20
30,5	PL-260/05	PL-260/20
36,8	PL-261/05	PL-261/20

• SILICONE

• PVC

◀ inserts nickelés / nickel inserts

◀ inserts dorés / gold inserts

◀ inserts cristal / crystal inserts

Plaquettes à visser

Screw-on nose pads



● Plaquettes silicone

Silicone nose pads

● Plaquettes asymétriques

Asymmetrical nose pads

Taille Size mm	10 paires 10 pairs	20 paires 20 pairs	100 paires 100 pairs
15	PL-141/10	PL-141/20	PL-141/C
17	PL-142/10	PL-142/20	PL-142/C
19	PL-143/10	PL-143/20	PL-143/C



● Plaquettes symétriques

Symmetrical nose pads

9	PL-144/10	PL-144/20	PL-144/C
11	—	PL-145/20	PL-145/C
13	PL-140/10	PL-140/20	PL-140/C
15	PL-275/10	PL-275/20	PL-275/C
17	PL-276/10	PL-276/20	PL-276/C
19	PL-277/10	PL-277/20	PL-277/C



13	PL-269/10	PL-269/20	PL-269/C
16	PL-270/10	PL-270/20	PL-270/C
19	PL-271/10	PL-271/20	PL-271/C



● Plaquettes souples en PVC

Soft PVC nose pads

Inserts métalliques

Metal inserts

● Plaquettes asymétriques

Asymmetrical nose pads

Inserts nickelés

nickel inserts

Taille Size mm	10 paires 10 pairs	20 paires 20 pairs	100 paires 100 pairs
12	PL-075/10	PL-075/20	PL-075/C
14,3	PL-076/10	PL-076/20	PL-076/C
17,5	PL-382/10	PL-382/20	PL-382/C
19	PL-102/10	PL-102/20	PL-102/C
12	PL-112/10	PL-112/20	PL-112/C
14,3	PL-106/10	PL-106/20	PL-106/C
17,5	PL-385/10	PL-385/20	PL-385/C
19	PL-110/10	PL-110/20	PL-110/C



Inserts dorés

gold inserts

● Plaquettes symétriques

Symmetrical nose pads

Inserts nickelés

nickel inserts

12	PL-380/10	PL-380/20	PL-380/C
15	PL-073/10	PL-073/20	PL-073/C
17,2	PL-099/10	PL-099/20	PL-099/C
12	PL-383/10	PL-383/20	PL-383/C
15	PL-113/10	PL-113/20	PL-113/C
17,2	PL-107/10	PL-107/20	PL-107/C



Inserts dorés

gold inserts

Inserts en polycarbonate

Polycarbonate inserts

● Plaquettes asymétriques

Asymmetrical nose pads

Taille Size mm	10 paires 10 pairs	20 paires 20 pairs	100 paires 100 pairs
15	PL-220/10	PL-220/20	PL-220/C
17	PL-221/10	PL-221/20	PL-221/C
19	PL-222/10	PL-222/20	PL-222/C



● Plaquettes symétriques

Symmetrical nose pads

9	PL-218/10	PL-218/20	PL-218/C
13	PL-219/10	PL-219/20	PL-219/C
12	PL-397/10	PL-397/20	PL-397/C
15	PL-398/10	PL-398/20	PL-398/C
17	PL-399/10	PL-399/20	PL-399/C





Plaquettes à visser

Screw-on nose pads

● Plaquettes dures en acétate

Hard acetate nose pads



Taille Size mm	10 paires 10 pairs	20 paires 20 pairs	100 paires 100 pairs	
	17,5 17,5	PL-090/10 PL-095/10	PL-090/20 PL-095/20	PL-090/C PL-095/C
				Plaquettes symétriques Symmetrical nose pads
				◀ inserts nickelés / nickel inserts
				◀ inserts dorés / gold inserts

Taille Size mm	5 paires 5 pairs	
	13,8	PL-366/05

● **Plaquettes souples auto-ajustantes**
avec séparation entre la surface de contact et l'attache sur monture
Soft self adjusting nose pads
with separation between the contact surface and the fastening on frame



● Plaquettes ultra-fines monobloc

Solid ultra-thin pads

Taille Size mm	10 paires/pairs	20 paires/pairs	100 paires/pairs	
	10 12 14	PL-214/10 PL-215/10 PL-216/10	PL-214/20 PL-215/20 PL-216/20	PL-214/C PL-215/C PL-216/C
				• Plaquettes ultra-fines, épaisseur = 1 mm en matière dure, hypoallergénique <i>Ultra-thin nose pads, thickness : 1 mm in hard material, hypoallergenic</i>
	1 2 3	ovale / oval goutte de suif / drop shape rectangulaire / rectangular		
		PL-211/10	PL-211/20	PL-211/C
		PL-212/10	PL-212/20	PL-212/C
		PL-210/10	PL-210/20	PL-210/C
				• Plaquettes ultra-fines, souples, en PVC (ép. 1 mm) <i>Soft ultra-thin nose pads</i>

● Plaquettes jumelées

Saddle pads

Taille Size mm	5 pcs	20 pcs	
	23,3 30,5 36,8	PL-147/05 PL-148/05 PL-149/05	PL-147/20 PL-148/20 PL-149/20
			• SILICONE SILICONE
	32 36 32 36	PL-150/05 PL-155/05 PL-151/05 PL-156/05	PL-150/20 PL-155/20 PL-151/20 PL-156/20
			• PVC SOUPLE SOFT PVC
			◀ Inserts nickelés / nickel inserts
			◀ Inserts dorés / gold inserts
	23,3 30,5 36,8	PL-249/05 PL-250/05 PL-251/05	PL-249/20 PL-250/20 PL-251/20
			◀ Inserts cristal / crystal inserts

Plaquettes diverses

Varied nose pads



Plaquettes air-active

Air-active nose pads

Confort maximum avec ces plaquettes en silicone avec coussin d'air. Munies d'une valve, elles permettent d'équilibrer le volume d'air en fonction de la pression exercée par la monture.

Maximum comfort with these silicone nose pads with air cushion. They include a valve which enables to balance the air volume according to the pressure exerted by the frame.

	Taille / Size mm	1 paire / 1 pair	12 paires / 12 pairs
à visser / screw-on	11	PL-370/01	PL-370/12
	14,5	PL-371/01	PL-371/12
	17	PL-372/01	PL-372/12
à clipper / push-on	13	PL-376/01	PL-376/12
	14,5	PL-377/01	PL-377/12
	17	PL-378/01	PL-378/12

Plaquettes monobloc

Solid nose pads

- Plaquettes silicone / Silicone nose pads
- (1) Pied rectangulaire / Rectangular foot

- Plaquettes polycarbonate + coiffe silicone / Polycarbonate nose pads + silicone coating

- Plaquettes PVC / PVC nose pads

- Plaquettes polycarbonate / Polycarbonate nose pads

Taille / Size mm	10 paires / 10 pairs	100 paires / 100 pairs	Forme plaquette et pied / Nose pad and foot shape
Ronde / Round 9,5 Ronde / Round 11	PL-138/10 PL-139/10	PL-138/C PL-139/C	
Ovale / Oval 10,5 Ovale / Oval 12	PL-133/10 PL-131/10	PL-133/C PL-131/C	
Rectangul. 10,5 (1)	PL-132/10	PL-132/C	
Ronde / Round 9,5	PL-137/10	PL-137/C	
Ronde / Round 9,5	PL-136/10	PL-136/C	
Ovale / Oval 12	PL-134/10	PL-134/C	

Plaquettes en titane pur (totalement anallergiques)

Nose pads in pure titanium (no allergy)

- Plaquettes à visser / Screw-on nose pads

- Plaquettes à clipper / Push-on nose pads

Taille / Size mm	Sachet de 1 paire / Bag of 1 pair	
	Titane / Titanium	Doré / Gold
8,0	PL-116/1	PL-116/D1
12	PL-117/1	PL-117/D1
8,0	PL-126/1	PL-126/D1
12	PL-124/1	PL-124/D1



Plaquettes de nez type "Primadonna"

Primadonna type nose pads

		5 paires / pairs	20 paires / pairs	100 paires / pairs	
PVC	2	13 mm	PL-341/05	PL-341/20	PL-341/C
	3	15 mm	PL-342/05	PL-342/20	PL-342/C
	4	17 mm	PL-343/05	PL-343/20	PL-343/C
SILICONE	1	9 mm (0)	PL-345/05	PL-345/20	PL-345/C
	2	13 mm	PL-346/05	PL-346/20	PL-346/C
	3	15 mm	PL-347/05	PL-347/20	PL-347/C
	4	17 mm	PL-348/05	PL-348/20	PL-348/C



Plaquette type Silhouette, en acétate, dure, 12 x 7,4 mm

Silhouette type nose pad, acetate, hard, 12 x 7,4 mm

PL-320/05

Sachet de 5 paires / Bag of 5 pairs

PL-320/20

Sachet de 20 paires / Bag of 20 pairs



Plaquettes type B + L (5 paires)

B+L type nose pads (5 pairs)

Plaquettes 17 mm / Nose pads 17 mm / Acetate	Cristal / Crystal	PL-200/5	
--	-------------------	----------	--

Assortiments de plaquettes

Sets of nose pads

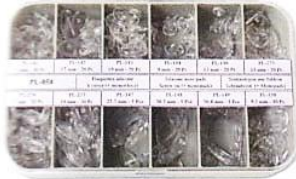

Plaquettes à clipper

Push-on nose pads

PL-060

ASSORTIMENT DE PLAQUETTES en silicone (asymétriques et symétriques) + plaquettes jumelées (170 paires + 15 pièces jumelées)
SET OF SILICONE NOSE PADS, (asymmetrical and symmetrical) + saddle pads (170 pairs + 15 pieces saddle pads)

CASE	RÉFÉRENCE STOCK N°	QUANTITÉ QUANTITY
1	PL-179	20 paires/pairs
2	PL-180	"
3	PL-181	"
4	PL-182	"
5	PL-178	"
6	PL-285	"
7	PL-286	"
8	PL-287	"
9	PL-183	5 pièces/pièces
10	PL-184	"
11	PL-185	"
12	PL-138	20 pièces/pièces

PL-054

ASSORTIMENT DE PLAQUETTES souples en PVC, Inserts métalliques (nickelés ou dorés) + plaquettes jumelées (160 paires + 15 pièces jumelées)
SET OF SOFT PVC NOSE PADS metal inserts (nickel or gold colour) + saddle pads (160 pairs + 15 pieces saddle pads)

CASE	RÉFÉRENCE STOCK N°	QUANTITÉ QUANTITY
1	PL-182	20 paires/pairs
2	PL-187	"
3	PL-159	"
4	PL-160	"
5	PL-176	5 pièces/pièces
6	-	"
7	PL-172	20 paires/pairs
8	PL-168	"
9	PL-169	"
10	PL-170	"
11	PL-175	5 pièces/pièces
12	-	"

PL-056

ASSORTIMENT DE PLAQUETTES souples en PVC, Inserts polycarbonate + plaquettes dures ultra fines et plaquettes jumelées (180 paires + 15 pièces jumelées)
SET OF SOFT PVC NOSE PADS with polycarbonate inserts + ultra thin nose pads + saddle pads (180 pairs + 15 pieces saddle pads)

CASE	RÉFÉRENCE STOCK N°	QUANTITÉ QUANTITY
1	PL-232	20 paires/pairs
2	PL-238	"
3	PL-239	"
4	PL-240	"
5	PL-241	"
6	PL-242	"
7	PL-234	"
8	PL-235	"
9	PL-236	"
10	PL-259	5 pièces/pièces
11	PL-260	"
12	PL-261	"

Plaquettes à visser

Screw-on nose pads

PL-058

ASSORTIMENT DE PLAQUETTES en silicone (asymétriques et symétriques) + plaquettes jumelées (170 paires + 15 pièces jumelées)
SET OF SILICONE NOSE PADS, (asymmetrical and symmetrical) + saddle pads (170 pairs + 15 pieces saddle pads)

CASE	RÉFÉRENCE STOCK N°	QUANTITÉ QUANTITY
1	PL-141	20 paires/pairs
2	PL-142	"
3	PL-143	"
4	PL-144	"
5	PL-140	"
6	PL-275	"
7	PL-276	"
8	PL-277	"
9	PL-147	5 pièces/pièces
10	PL-148	"
11	PL-149	"
12	PL-138	20 pièces/pièces

PL-052

ASSORTIMENT DE PLAQUETTES souples en PVC, Inserts polycarbonate + plaquettes dures ultra fines et plaquettes jumelées (180 paires + 15 pièces jumelées)
SET OF SOFT PVC NOSE PADS with polycarbonate inserts + ultra thin nose pads + saddle pads (180 pairs + 15 pieces saddle pads)

CASE	RÉFÉRENCE STOCK N°	QUANTITÉ QUANTITY
1	PL-212	20 paires/pairs
2	PL-218	"
3	PL-219	"
4	PL-220	"
5	PL-221	"
6	PL-222	"
7	PL-214	"
8	PL-215	"
9	PL-216	"
10	PL-249	5 pièces/pièces
11	PL-250	"
12	PL-251	"

PL-050

ASSORTIMENT DE PLAQUETTES souples en PVC, Inserts métalliques (nickelés ou dorés) + plaquettes jumelées (160 paires + 20 pièces jumelées)
SET OF SOFT PVC NOSE PADS metal inserts (nickel or gold colour) + saddle pads (160 pairs + 20 pieces saddle pads)

CASE	RÉFÉRENCE STOCK N°	QUANTITÉ QUANTITY
1	PL-075	20 paires/pairs
2	PL-076	"
3	PL-382	"
4	PL-102	"
5	PL-150	5 pièces/pièces
6	PL-155	"
7	PL-112	20 paires/pairs
8	PL-106	"
9	PL-385	"
10	PL-110	"
11	PL-151	5 pièces/pièces
12	PL-156	"



TO-088 Disque feutre dur Ø 76 mm, ép. 25 mm
Hard felt wheel, Ø 76 mm, th. 25 mm

TO-089 Disque feutre dur Ø 102 mm, ép. 25 mm
Hard felt wheel, Ø 102 mm, th. 25 mm

TO-090 Disque feutre dur Ø 152 mm, ép. 25 mm
Hard felt wheel, Ø 152 mm, th. 25 mm

TO-091 Disque feutre dur Ø 102 mm, ép. 19 mm
avec gorge en V
Hard felt wheel, Ø 102 mm, th. 19 mm
with V groove

TO-080 Disque feutre mi-dur Ø 80 mm, ép. 20 mm
Half hard felt wheel, Ø 80 mm, th. 20 mm

TO-082 Disque feutre mi-dur Ø 100 mm, ép. 25 mm
Half hard felt wheel, Ø 100 mm, th. 25 mm

TO-092 Lentille feutre dur Ø 102 mm, ép. 20 mm
Knife edge hard felt wheel, Ø 102 mm,
th. 20 mm

TO-094 Lentille feutre mi-dur Ø 80 mm, ép. 20 mm
Knife edge half hard felt wheel, Ø 80 mm,
th. 20 mm

TO-020 Disque feutre souple, centre plastique,
Ø 100 mm, ép. 14 mm
Soft felt wheel, plastic center, Ø 100 mm, th. 14 mm

TO-077 Disque fils coton, centre plastique,
Ø 95 mm, ép. 16 mm
Circular cotton yarn brush. Plastic center,
Ø 95 mm, th. 16 mm

TO-074/125 Disque toile, centre plastique,
Ø 125 mm, ép. 12 mm
Nettle cloth wheel, plastic center,
Ø 125 mm, th. 12 mm

TO-076/125 Disque flanelle, centre plastique,
Ø 125 mm, ép. 14,5 mm
Flannel wheel, plastic center,
Ø 125 mm, th. 14,5 mm

TO-075 Disque chamois, centre plastique,
Ø 90 mm, ép. 6 mm
Leather wheel, plastic center, Ø 90 mm, th. 6 mm

TO-095 Disque caoutchouc abrasif (grain fin 250),
Ø 100 mm, ép. 20 mm
Abrasive rubber wheel (thin grit 250),
Ø 100 mm, th. 20 mm

Fouritures pour le polissage

Polishing supplies



Fournitures pour le polissage

Polishing supplies



- CO-200** Composition à polir rouge pour métaux
Red polishing compound for metals
- CO-201** Composition à polir jaune pour plastiques
Yellow polishing compound for plastics
- CO-202** Composition à polir blanc (très fin) pour métaux
White super fine polishing compound for metals
- CO-203** Composition à polir bleu de super finition pour tous métaux
Blue super finishing compound for all metals

- CO-220** Composition à polir de lapideur (polissage des verres organiques)
Fine polishing compound for organic lenses

- CO-225/100** Composition à polir (polissage des verres organiques et polycarbonate) - 100 g
Polishing compound for organic and polycarbonate lenses - 100 g

- CO-218** Composition à polir bleu spéciale (avec gaine métal) pour le polissage du bord des verres organiques. 30 x 20 x 115 mm
Blue polishing compound (in metal sleeve). Special paste for polishing the edge of organic lenses. 30 x 20 x 115 mm

- CO-211/100** Pâte à polir universelle en tube (100 ml) Utilisation facile avec ou sans moyen mécanique
Universal polishing paste in tube (100 ml) Easy use with or without mechanical means

- Gomme abrasive pour nettoyer et polir les métaux et plastiques
Abrasive rubber for cleaning and polishing metals and plastics
- GO-100** Fin (grain : 240)
Fine (grit : 240)
 - GO-101** Moyen (grain : 120)
Medium (grit : 120)

Instruments de traçage et marquage

Markers and scribing instruments

- 1 **PO-099** POINTE A TRACER FINE
avec 2 pointes de rechange dans le manche
SCRIBER with 2 replacement pins in handle
- 2 **PO-099/10** Pointes de rechange (10 pcs)
Replacement pins (10 pcs)

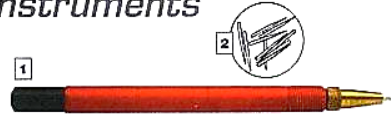

- 3 **PO-096** POINTE A TRACER au carbure de tungstène
CARBIDE SCRIBER in tungsten carbide
- 4 **PO-096/1** Pointe de rechange pour PO-096
Replacement tip for PO-096



- 5 **DI-101** DIAMANT A MAIN petit sabot
DIAMOND GLASS CUTTER



- 6 **CO-500** COUPE VERRE A MOLETTE
WHEEL CUTTING TOOL

- 7 **CO-500/1** Molettes de rechange (3 pcs)
Replacement wheels (3 pcs)

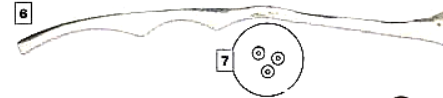

- 8 **EQ-400**
ÉQUERRE DE PRÉCISION 100 x 70
PRECISION SQUARE 100 x 70

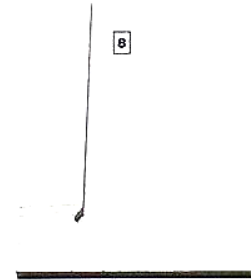

- 9 **CO-400**
COMPAS 75 mm
DIVIDER 75 mm

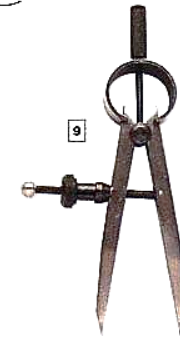

- CR-100/3** CRAYON GRAS blanc (3 pcs)
CHINA MARKER white (3 pcs)



- CR-101/3** CRAYON GRAS rouge (3 pcs)
CHINA MARKER red (3 pcs)



- CRAYONS PERMANENTS Lumocolor (3 pcs)
PERMANENT MARKER Lumocolor (3 pcs)

- CR-110/3** Noir super fin pour verres normaux
Black super fine for normal lenses
- CR-111/3** Rouge super fin pour verres normaux
Red super fine for normal lenses
- CR-115/3** Noir fin pour verres traités
Black fine for coated lenses
- CR-116/3** Rouge fin pour verres traités
Red fine for coated lenses
- CR-117/3** Noir super fin pour verres traités
Black superfine for coated lenses



- GO-109** GOUACHE blanc uni POSCA,
trait fin 1,0 mm
White soluble LENS MARKER POSCA
fine line 1.0 mm

- GO-110** GOUACHE blanc uni POSCA trait fin 1,5 mm
White soluble LENS MARKER POSCA
fine line 1.5 mm

- GO-111** GOUACHE blanc uni POSCA trait large 2,5 mm
White soluble LENS MARKER POSCA
large line 2.5 mm



Potence à river

Staking tool

LA POTENCE A RIVER est destinée à de multiples travaux sur les montures, les branches de lunettes (chasser, river, poser, marquer, etc.)
 THE STAKING TOOL is designed for optical works on frames, temples (driving out, penning, setting, marking, etc.)

- PO-102** KIT DE POTENCE A RIVER comprenant :
 STAKING TOOL KIT including :
- 1 Potence à river / 1 Staking tool (PO-102/00)
 - 19 Accessoires du PO-102/01 au PO-102/19 (voir le détail ci-dessous)
 - 19 Accessories from PO-102/01 to PO-102/19 (see detail here-below)

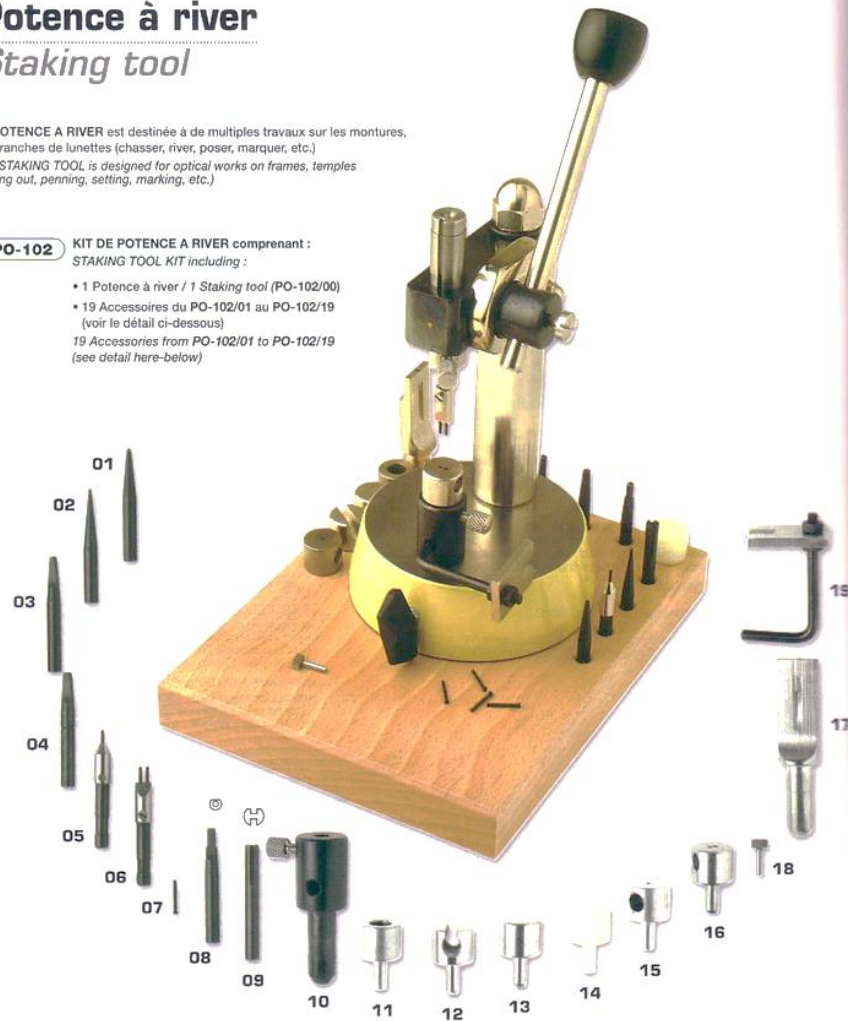

Outils et accessoires de rechange / Replacement tools and accessories

- | | |
|---|--|
| PO-102/01 Pointeau à pointe fine
Pointed punch | PO-102/11 Tasseau gros trou
Round hole anvil |
| PO-102/02 Chasse-goupille
Blunt punch | PO-102/12 Tasseau avec rainure
Oval hole anvil |
| PO-102/03 Outil à bouteroller les petits rivets
Peening tool for small rivets | PO-102/13 Tasseau massif acier
Solid anvil steel |
| PO-102/04 Outil à bouteroller les gros rivets
Peening tool for large rivets | PO-102/14 Tasseau massif nylon
Solid anvil nylon |
| PO-102/05 Perçoir simple Ø 1,2
Single piercing punch Ø 1.2 | PO-102/15 Tasseau 1 petit trou
Single pin anvil |
| PO-102/06 Perçoir double Ø 1,2
Double piercing punch Ø 1.2 | PO-102/16 Tasseau 2 petits trous
Double pin anvil |
| PO-102/07 Perçeurs Ø 1,2 (10 pcs)
Pins Ø 1.2 (10 pcs) | PO-102/17 Tasseau face étroite
Narrow face anvil |
| PO-102/08 Outil à poser 1 rivet
Single rivet setting tool | PO-102/18 Petite enclume pour PO-102/17
Base pin for PO-102/17 |
| PO-102/09 Outil à poser 2 rivets
Double rivet setting tool | PO-102/19 Extracteur de perçoirs
Piercing punch extractor |
| PO-102/10 Porte-tasseau
Anvil holder | |

Potence à river - options

Staking tool - options



Cintrer le pont

Bending bridge

Dispositif de cintrage du pont
Bridge bending device

PO-102/50



Chasser les rivets

Driving out rivets

Dispositif de positionnement
pour chasser les rivets
Positioning device to drive out rivets

PO-102/60



Chasser les vis

Driving out screws

Tasseaux pour chasser les vis cassées
Anvils for driving out broken screws

- | | | |
|----------|------------------|---------------------------|
| 1 | PO-102/70 | Tasseau
Anvil Ø 1,5 mm |
| 2 | PO-102/71 | Tasseau
Anvil Ø 1,8 mm |
| 3 | PO-102/72 | Tasseau
Anvil Ø 2,3 mm |



Marquer les verres et les branches

(plastique ou polycarbonate)

Marking punch for lenses and temples

(plastic or polycarbonate)

PO-200/01 à / to **PO-200/06**

Poinçon à marquer 6 lettres ou signes maximum.
Hauteur standard : 1,5 mm
Ex. : 2 caractères → réf. : PO-200/02
Marking punch 6 letters or signs maximum.
Standard height : 1,5 mm
Ex. : 2 characters → ref. : PO-200/02

PO-200/CE

Poinçon CE / Punch CE



Râteliers

Racks

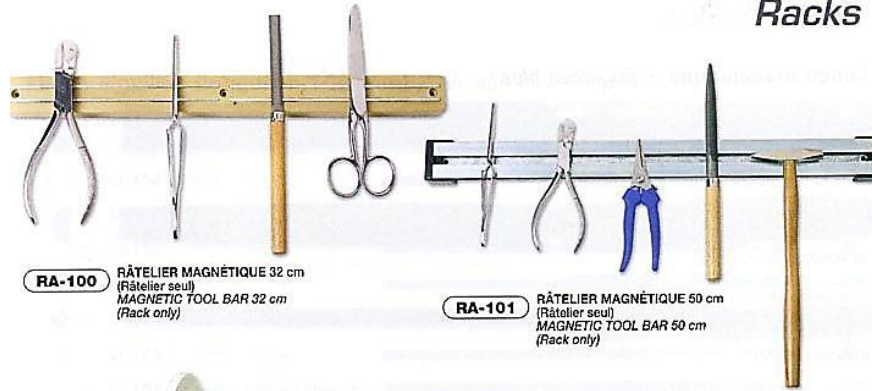

RA-100 RÂTELIER MAGNÉTIQUE 32 cm
(Râtelier seul)
MAGNETIC TOOL BAR 32 cm
(Rack only)

RA-101 RÂTELIER MAGNÉTIQUE 50 cm
(Râtelier seul)
MAGNETIC TOOL BAR 50 cm
(Rack only)

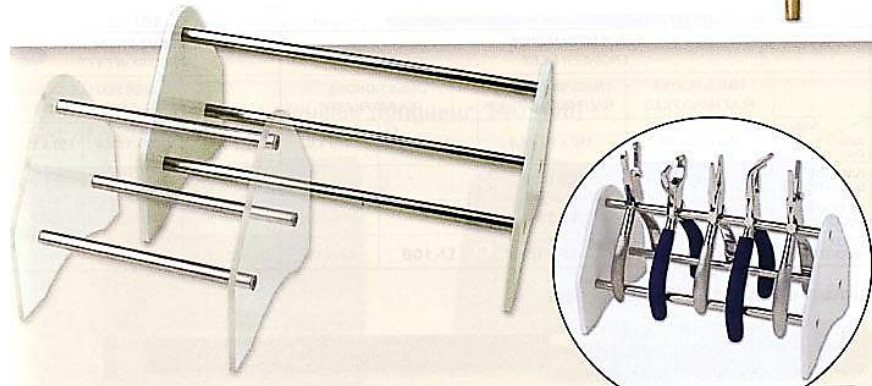

RÂTELIERS À PINCES - Flasques en plastique, tiges en acier inoxydable
PLIER RACKS - Plates in plastic, rods in stainless steel

Avec flasques blanches With white plates	Avec flasques cristal With crystal plates	Description Description
RA-119	RA-119/CR	120 mm - Capacité approx. 5 pinces / Approx. capacity 5 pliers
RA-120	RA-120/CR	200 mm - Capacité approx. 8 pinces / Approx. capacity 8 pliers
RA-121	RA-121/CR	280 mm - Capacité approx. 11 pinces / Approx. capacity 11 pliers

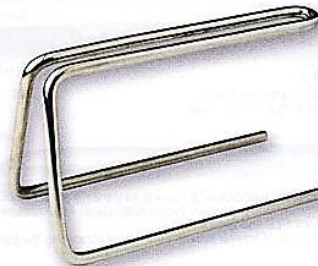

Retouche Repair



Électro-placage pour retouche locale Electroplating for local repair

Le système d'ÉLECTRO-PLACAGE par stylos permet à une personne non spécialisée de réaliser facilement et rapidement des dépôts métalliques sur des parties de montures, accessoires et petites pièces. La solution d'électro-placage prête à l'emploi est contenue dans des stylos d'une capacité de 10 ml permettant de couvrir une surface de 60 x 60 cm. Les stylos ne sont pas rechargeables.

The PEN ELECTROPLATING system allows any person without specialized skills to carry out metal deposition on frame parts, accessories and small parts, easily and quickly. The electroplating solution is ready for use and is held in 10 ml pens allowing to cover a 60 x 60 cm surface. Pens are not refillable.

AP-219 KIT D'ÉLECTRO-PLACAGE comprenant :
PEN PLATING KIT including :

- 1 Appareil seul / 1 Machine only - **AP-220**
- 1 Stylo de dégraissage / 1 degreaser Pen - **AP-221**
- 1 Stylo or jaune / 1 yellow plating Pen - **AP-222**
- 1 Stylo couleur chrome / 1 chrome colour plating Pen - **AP-224**

Fournitures / Supplies



AP-221
Stylo de dégraissage électrolytique
Degreaser pen



AP-222
Stylo or jaune 18 K
18 K yellow gold plating pen



AP-223
Stylo or rose 18 K
18 K pink gold plating pen



AP-224
Stylo couleur chrome
Chrome colour plating pen



AP-225
Stylo or jaune clair 14 K
14 K light yellow gold plating pen

Laques de retouche et de décoration

des montures métalliques.
Laques miscibles entre elles.

(l'expédition par avion est réglementée)

Frame repair paints
for repair and decoration
of metal frames. Paints are miscible.
(shipment by plane is regulated)



LA-226/A
Noir / Black

LA-226/AM
Noir mat / Mat black

LA-226/B
Brun foncé / Dark brown

LA-226/C
Havane / Light brown

LA-226/CR
Chrome / Chrome

LA-226/G
Blanc / White

LA-226/H
Vert / Green

LA-226/J
Jaune / Yellow

LA-226/K
Bleu / Blue

LA-226/M
Rouge / Red

LA-226/O
Or / Gold



LA-226 ASSORTIMENT DE LAQUES
DE RETOUCHE comprenant :
SET OF FRAME REPAIR PAINTS
including :

- LA-226/A
- LA-226/B
- LA-226/C
- LA-226/M
- LA-226/G
- LA-226/H

Roile-goupilles - Grattoirs

Broach holders - Scrapers

Roile-goupilles - Drille / Broach holders - Hand drill

RO-099 ROULE-GOUPILLE TÊTE CARRÉE 2 pinces, serrages : 0 à 2,0 mm, longueur 8 cm
BROACH OR TAP HOLDER SQUARE HEAD 2 chucks, capacity : 0 to 2.0 mm, 8 cm long



RO-100 ROULE-GOUPILLE TÊTE CARRÉE 2 pinces, serrages : 0 à 2,1 mm, longueur 10 cm
BROACH OR TAP HOLDER SQUARE HEAD 2 chucks, capacity : 0 to 2.1 mm, 10 cm long



RO-105 ROULE-GOUPILLE DOUBLE avec 2 pinces réversibles, serrages : 0 à 3,2 mm
DOUBLE END BROACH OR TAP HOLDER with 2 reversible chucks, capacity : 0 to 3.2 mm



RO-101 ROULE-GOUPILLE PAUME TOURNANTE avec 2 pinces réversibles, serrages : 0 à 3,2 mm
SWIVEL HEAD BROACH OR TAP HOLDER with 2 reversible chucks, capacity : 0 to 3.2 mm



RO-107 ROULE-GOUPILLE PAUME TOURNANTE EN BOIS 2 pinces, serrages 0 à 2,3 mm
BROACH OR TAP HOLDER WITH OVERSIZED WOOD HANDLE 2 chucks, capacity : 0 to 2.3 mm



Grattoirs / Scrapers

1 GR-100 GRATTOIR A LAME RÉVERSIBLE ET INTERCHANGEABLE
SCRAPER WITH REVERSIBLE AND INTERCHANGEABLE BLADE

GR-100/1 Lame de rechange (pc)
Replacement blade (pc)

2 GR-120 GRATTE-BROSSE fils maillechort / SCRATCH BRUSH silver nickel wires

GR-121 Rechange fils maillechort (3 pcs)
Replacement brush (3 pcs)

3 GR-122 GRATTE-BROSSE fils fibre de verre / SCRATCH BRUSH glass wires

GR-123 Rechange fibre de verre (3 pcs)
Replacement brush (3 pcs)

4 GR-105 GRATTOIR manche bois
SCRAPER with wood handle

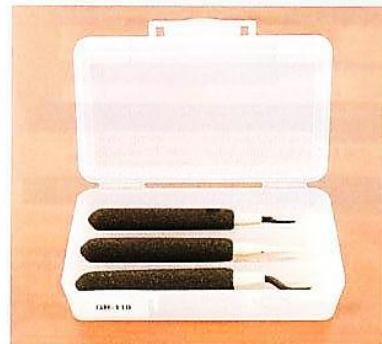

GR-110
Kit de 3 pièces contenant un grattoir (GR-104), un ébavureur (EB-100) et un chanfreineur (CH-300)
SET OF 3 PIECES including a scraper (GR-104), a tool for removing burrs (EB-100) and a chamferer (CH-300)



GR-104
GRATTOIR triangulaire fixe, lame fine
Fixed triangular SCRAPER with thin blade



CH-300
CHANFREINEUR manuel à lame pivotante
Manual CHAMFERER with swivelling blade



EB-100
ÉBAVUREUR à lame pivotante
TOOL for removing burrs with swivelling blade

Soudage

Soldering



CH-240

CHALUMEAU rechargeable, allumage Piezo, flamme ajustable 1300° C (livré sans gaz)
 REFILLABLE TORCH, Piezo ignition, adjustable flame 1300° C (delivered without gas)

CH-211 Gaz pour CH-240 (223 g)
 Gas for CH-240 (223 g)



CH-205

CHALUMEAU sur cartouche de gaz jetable, flamme ajustable 1600° C, tête simple
 TORCH on disposable gas cartridge, adjustable flame 1600° C, simple head

CH-226 CARTOUCHE DE GAZ jetable, 40 g, pour CH-205 et CH-220
 DISPOSABLE GAS CARTRIDGE 40 g for CH-205 and CH-220

AP-310

APPAREIL ÉLECTRIQUE À SOUDER AU CHARBON - TITTA - équipé d'un réglage de température, de pinces de blocage et d'une pédale de commande.

ELECTRIC CARBON SOLDERING MACHINE "TITTA" with a variable temperature thermostat, an adjustable holding clamp and a convenient control foot pedal.
 220/240 V - Poids / Weight : 3,8 kg
 Dimensions / Size : 156 x 180 x 180

PIÈCES DE RECHANGE / REPLACEMENT PARTS



AP-310/5

Charbon, diamètre 8,3 mm (1 pièce)
 Carbon rod, diameter 8.3 mm (1 piece)

ATTENTION ! L'expédition du gaz et de l'oxygène est réglementée. Le gaz et l'oxygène doivent être expédiés dans des colis séparés. Expédition uniquement par transporteur agréé.
BE CAREFUL ! The shipment of gas and oxygen is regulated. Gas and oxygen must be shipped separately. Shipment only by approved carrier.



CH-220

CHALUMEAU MICROTORCH POUR SOUDURE DE PRÉCISION avec manomètre de contrôle d'oxygène. Flamme ajustable 2750° C. Livré dans un coffret comprenant : 1 distributeur, 1 stylo microtorch, 1 support de stylo, 2 cartouches d'oxygène, 6 buses aiguilles (6, 8, 10 et 12/10 de mm) + (1 cartouche de gaz livrée séparément).

MICROTORCH FOR PRECISION SOLDERING with oxygen control gauge. Adjustable flame 2750° C (5000° F). In its own stow away kit which contains : 1 distributor, 1 microtorch pen, 1 pen stand, 2 oxygen canisters, 6 needle tips (6, 8, 10 and 12/10 mm) + (1 gas cartridge delivered separately).

OX-099 OXYGÈNE en cartouche jetable (1litre à 12 bars) 13 g
 OXYGEN in disposable canister



AIGUILLES DE RECHANGE POUR CH-220
 REPLACEMENT NEEDLES FOR CH-220

CH-225/06 2 pcs 6/10 mm CH-225/10 2 pcs 10/10 mm
 CH-225/08 2 pcs 8/10 mm CH-225/12 2 pcs 12/10 mm



EQ-130

EQUARRISOIRS pour déboucher les aiguilles / buses (2 pièce)
 Diam. : 0,5 et 0,7 mm
 HAND CUTTING BROACHES to clean needle tips (2 pieces)
 Diam. : 0,5 and 0,7 mm



Fournitures Supplies

OX-099

CARTOUCHE D'OXYGÈNE JETABLE de 1 litre à 12 bars (13 g) pour **CH-220**
OXYGEN at 12 bars (13 g) in disposable 1 liter canister for **CH-220**



CH-211

GAZ pour **CH-240** (223 g)
GAS for **CH-240** (223 g)



CH-226

CARTOUCHE DE GAZ jetable,
40 g, pour **CH-205** et **CH-220**
DISPOSABLE GAS CARTRIDGE
40 g, for **CH-205** and **CH-220**

CH-216

BORAX LIQUIDE
1/4 litre
LIQUID BORAX
1/4 liter



FLUX UNIVERSEL en pâte
pour le brasage.
Plage de travail : 500-800° C
FLUX in paste for brazing.
Temperat. range : 500-800° C

CH-215 100 g

CH-217

PÂTE ISOLANTE protège et isole la proximité des soudures sans laisser de traces
INSULATING PASTE protects and insulates the area right next to the solder
without leaving a stain



SOUUDRE UNIVERSELLE A L'ARGENT en baguettes tubulaires avec flux incorporé.
12 baguettes de 15 cm. Point de fusion : 630° C
UNIVERSAL SILVER SOLDER in stick form with incorporated flux.
12 sticks of 15 cm. Melting temperature : 630° C



SO-100 Blanc / White

SO-101 Jaune / Yellow

SOUUDRE À L'ARGENT P.D. (Fabriqué en Suisse)
en baguettes de 15 cm avec flux incorporé. Point de fusion : 650° C
SILVER SOLDER P.D. (Made in Switzerland)
in stick of 15 cm with incorporated flux. Melting temperature : 650° C

SO-110

Blanc - 12 baguettes
White - 12 sticks

SO-111

Jaune - 12 baguettes
Yellow - 12 sticks



SO-115

SOUUDRE À L'ARGENT en fil Ø 0,5 mm (2 mètres). Point de fusion : 650° C
SILVER SOLDER in wire Ø 0.5 mm (2 meters. Melting temperature : 650° C)



SO-117

BRASURE À L'ARGENT
600 AG L3 en bobine de 2 g.
Point de fusion : 680° C
SILVER HARD SOLDER 600
600 AG L3 in 2 g spool
Melting temperature : 680° C

ST-105

STYLO PORTE SOUDURE
pour **SO-115** et **SO-117**
SOLDERING WIRE PENCIL for **SO-115** et **SO-117**



TR-100

TROISIÈME MAIN
THIRD HAND

TR-100/1

Pincés de rechange (2 pcs)
Replacement alligator jaws (2 pcs)



TR-101

TROISIÈME MAIN inox
Stainless steel THIRD HAND

TR-101/1

Pincés de rechange (2 pcs)
Replacement jaws (2 pcs)



TR-110

TABLE A SOUDRE avec 2 bras + pincés
SOLDERING TABLE with 2 arms + pliers

TR-110/2

Bras + Pince supplémentaire (1 pc)
Replacement arm + Plier (1 pc)

TR-110/1

Pince de rechange (1 pc)
Replacement plier (1 pc)

Tarauds

Taps



TA-200 ASSORTIMENT DE TARAUDS ET POINTE DE CENTRAGE
comprenant :
SET OF TAPS
AND CENTER FINDER
including :

- 8 tarauds montés du TA-200/A08 au TA-200/A18
- 1 pointe de centrage TA-200/060 (voir tableau ci-contre)
- 8 mounted taps from TA-200/A08 to TA-200/A18
- 1 center finder TA-200/060 (See board on the right)

RÉFÉRENCE STOCK N°	DIAM. mm
TA-200/A08	0,8
TA-200/A10	1,0
TA-200/A12	1,2
TA-200/A13	1,3
TA-200/A14	1,4
TA-200/A15	1,5
TA-200/A16	1,6
TA-200/A18	1,8
Pointe de centrage Center finder	TA-200/060

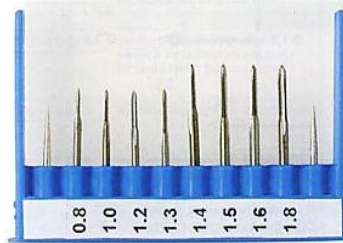

TA-201 ASSORTIMENT DE 8 TARAUDS ET 2 POINTES pour TA-200
SET OF 8 TAPS AND 2 CENTER FINDERS for TA-200

Tarauds et outils en sachet Taps and tools in bag

R	
	TARAUD A QUEUE CYLINDRIQUE (pour roule-goupille) CYLINDRICAL SHANK TAP (for universal tap holder)
S	
	TARAUD A QUEUE AVEC MÉPLAT (pour TA-200/A08 à TA-200/A18) FLAT SHANK TAP (for tools TA-200/A08 to TA-200/A18)
T	
	OUTILS (manche avec taraud) TOOLS (handle with tap)

Diamètre lige - mm Shank diameter - mm	Diamètre / Diameter mm	SACHET / BAG		
		3 pcs		1 pc
		R	S	T
		QUEUE CYLINDRIQUE CYLINDRICAL SHANK	QUEUE MÉPLAT FLAT SHANK	OUTILS TOOLS
1,5	0,8	TA-008/3	TA-108/3	TA-200/A08
	0,9	TA-009/3	-	-
	1,0	TA-010/3	TA-110/3	TA-200/A10
	1,1	TA-011/3	TA-111/3	-
	1,2	TA-012/3	TA-112/3	TA-200/A12
	1,3	TA-013/3	TA-113/3	TA-200/A13
2,0	1,4	TA-014/3	TA-114/3	TA-200/A14
	1,5	TA-015/3	TA-115/3	TA-200/A15
	1,6	TA-016/3	TA-116/3	TA-200/A16
	1,7	TA-017/3	-	-
	1,8	TA-018/3	TA-118/3	TA-200/A18
	1,9	TA-019/3	-	-
	2,0	TA-020/3	-	-
- Pointe de centrage / Center finder				TA-200/060



AP-440

APPAREIL POUR MESURER LE POURCENTAGE DE TRANSMISSION DES VISIBLES (400 à 700 nm) ET DES ULTRA-VIOLETS (320 à 400 nm).

Permet de mesurer chaque critère séparément ou les deux simultanément.
Alimentation par pile (1x9V) - PI-440/1
Dimensions : 100 x 130 x 120 mm. Poids : 860 g

MACHINE FOR MEASURING THE TRANSMISSION PERCENTAGE OF VISIBLE LIGHT (400 to 700 nm) AND ULTRA-VIOLET RAYS (320 to 400 nm).

Allows to measure each criterion separately or both criteria simultaneously.
Feeding by battery (1x9V) - PI-440/1
Size : 100 x 130 x 120 mm. Weight : 860 g



AP-447

APPAREIL MULTI-CONTROLE

Permet :

- la vérification du centrage des verres progressifs
- la reconnaissance des paraphes et marquages sur les verres progressifs
- la vérification des tensions
- la détection de défauts de surface

MULTITEST DEVICE

Allows :

- to check the centring of progressive lenses
- to identify initials and markings on progressive lenses
- to check strains
- to check surface defaults



AP-454

TENSISCOPE A MAIN
Fourni avec pile 9 V PI-440/1.
Dimensions : 48 x 100 x 55 mm
Poids : 175 g

HAND TENSISCOPE
Supplied with 9 V battery PI-440/1
Size : 48 x 100 x 55 mm. Weight : 175 g.



Possible en 110 volts
Possible in 110 volts

AP-456

APPAREIL TENSISCOPE tête inclinable

Le tensiscope permet de repérer les tensions qui pourraient créer des distorsions dans les verres organiques et faire à terme éclater les verres minéraux. Le montage d'un verre provoque toujours des tensions qui s'il faut éliminer. Le tensiscope permet de mettre en évidence ces tensions de façon plus accentuée. Ce tensiscope est le seul qui permet de régler l'inclinaison selon les différentes exigences.

220/240 volts. Poids : 930 g. Dimensions : 155 x 135 x 167 mm.

TENSISCOPE with titable head

The tensiscope makes the identification of strains on mounted lenses possible. Such strains can cause distortions and, in glass lenses, chips. There are always strains when mounting a lens. Any excessive strain shown by the tensiscope must be eliminated. This tensiscope is the only one with an adjustable inclination, according to the different needs.

220/240 volts. Weight: 930 g. Size: 155 x 135 x 167 mm



AP-455

APPAREIL TENSISCOPE, Standard
220/240 volts. Dimensions : 105 x 90 x 130 mm.
Poids : 1,0 kg.

STANDARD TENSISCOPE
220/240 volts. Size : 105 x 90 x 130 mm.
Weight: 1.0 kg.



Possible en 110 volts
Possible in 110 volts

AP-458

APPAREIL POUR LA LECTURE DES PARAPHES

Il permet :

- de repérer la marque du producteur du verre.
- de connaître le pouvoir additionnel du verre progressif.
- de vérifier et de retrouver les verres progressifs.

Appareil inclinable selon besoin.

Dimensions : 155 x 135 x 270 mm. Poids : 1,03 kg. 220/240 volts

MACHINE FOR READING INITIALS

Allows :

- to identify the brand of the lens manufacturer.
- to know the additional power of a progressive lens.
- to check and to find progressive lenses.

Machine tiltable according to need.
Size: 155 x 135 x 270 mm. Weight: 1.03 kg. 220/240 volts

Tournevis Screwdrivers



TO-101 TOURNEVIS A MORILLE corps aluminium, livré avec 3 lames plates (1,5 - 2,0 - 2,5) + 1 lame cruciforme (1,5)
SCREWDRIVER WITH SCREW CHUCK aluminium body, supplied with 3 flat blades (1.5 - 2.0 - 2.5) + 1 cross blade (1.5)

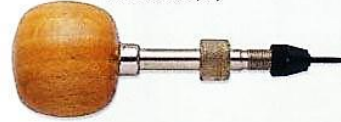

TO-114 TOURNEVIS AVEC TÊTE BOULE EN BOIS (2 lames plates Ø 1,5 et 2 mm)
SCREWDRIVER WITH OVERSIZED WOOD BALL HANDLE (2 flat blades Ø 1.5 and 2 mm)

LAMES DE RECHANGE POUR TO-101 ET TO-114 (3 pcs)
REPLACEMENT BLADES FOR TO-101 AND TO-114 (3 pcs)

TO-114/10		Plate / Flat Ø 1,0
TO-114/15		Plate / Flat Ø 1,5
TO-114/20		Plate / Flat Ø 2,0
TO-114/25		Plate / Flat Ø 2,5
TO-114/C15		Cruciforme / Cross Ø 1,5
TO-114/C20		Cruciforme / Cross Ø 2,0



TOURNEVIS type Essilor (voir tableau ci-contre)
Essilor type SCREWDRIVER (see opposite board)

	Tournevis (1 pc) Screwdriver (1 pc)	Lames (3 pcs) Blades (3 pcs)
Lame plate 1,5 mm Flat blade 1.5 mm	TO-150/A15	TO-150/B15
Lame plate 2,0 mm Flat blade 2.0 mm	TO-150/A20	TO-150/B20
Lame cruciforme 1,5 mm Cross blade 1.5 mm	TO-151/A15	TO-151/B15
Lame cruciforme 2,0 mm Cross blade 2.0 mm	TO-151/A20	TO-151/B20
	(1 pc)	(1 pc)
Clé pour érou de 2,2 mm Blade for 2.2 mm nut	TO-152/A22	TO-152/B22
Clé pour érou de 2,5 mm Blade for 2.5 mm nut	TO-152/A25	TO-152/B25



TO-875 TOURNEVIS AVEC ROULEMENT A BILLE (2 lames plates Ø 1,5 et 2 mm)
BALLBEARING SCREWDRIVER (2 flat blades Ø 1.5 and 2 mm)

LAMES DE RECHANGE POUR TO-875 (3 pcs)
REPLACEMENT BLADES FOR TO-875 (3 pcs)

TO-875/10		Plate / Flat Ø 1,0
TO-875/15		Plate / Flat Ø 1,5
TO-875/20		Plate / Flat Ø 2,0
TO-875/C15		Cruciforme / Cross Ø 1,5
TO-875/C20		Cruciforme / Cross Ø 2,0



TO-850 TOURNEVIS MANCHE LAITON Avec grosse tête plastique. Livré avec deux lames doubles : 1 lame double plate : 1,5 / 2,2 ; 1 lame double cruciforme : 1,5 / 2,0
BRASS HANDLE SCREWDRIVER With large plastic head. Delivered with two double blades : 1 flat double blade : 1.5 / 2.2 ; 1 cross double blade : 1.5 / 2.0

LAMES DE RECHANGE POUR TO-850 (3 pcs)
REPLACEMENT BLADES FOR TO-850 (3 pcs)

TO-850/5		Plate / Flat 1.5/2.2
TO-850/6		Cruciforme / Cross 1.5/2.0

TOURNEVIS AVEC LAME RÉVERSIBLE
SCREWDRIVERS WITH DOUBLE END BLADE



TO-112 TOURNEVIS lame plate Ø 1,5 / 2,2
SCREWDRIVER with flat blade Ø 1.5 / 2.2



TO-113 TOURNEVIS lame plate Ø 2,2, cruciforme Ø 2,5
SCREWDRIVER with flat blade Ø 2.2, cross blade Ø 2.5

LAMES DE RECHANGE POUR TO-111, TO-112 et TO-113 (3 pcs)
REPLACEMENT BLADES FOR TO-111, TO-112 AND TO-113 (3 pcs)

TO-111/1		Cruciforme / Cross 1.5/2,0
TO-112/1		Plate / Flat 1.5/2.2
TO-113/1		Cruciforme + plate 2.5/2.2 Cross + flat 2.5/2.2



TO-111 TOURNEVIS lame cruciforme Ø 1,5 / 2,0
SCREWDRIVER with cross blade Ø 1.5 / 2.0



CL-102/6 MANCHE pour TO-111, TO-112 et TO-113
HANDLE for TO-111, TO-112 and TO-113

Tournevis

Screwdrivers

TOURNEVIS LAME PLATE FLAT BLADE SCREWDRIVER



TO-120/A10	Tournevis lame plate / Flat Ø 1,0
TO-120/A15	Tournevis lame plate / Flat Ø 1,5
TO-120/A18	Tournevis lame plate / Flat Ø 1,8
TO-120/A23	Tournevis lame plate / Flat Ø 2,3



TO-121/A15	Tournevis lame cruciforme / Cross Ø 1,5
TO-121/A20	Tournevis lame cruciforme / Cross Ø 2,0
TO-121/A25	Tournevis lame cruciforme / Cross Ø 2,5

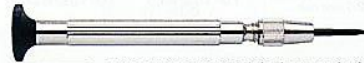

TO-130 TOURNEVIS À MORILLE tête large en plastique avec 4 lames (plates Ø 1,5 - 1,8 - 2,3 et cruciforme Ø 1,5)
SCREWDRIVER WITH SCREW CHUCK and large plastic head with 4 blades (flat blades Ø 1.5 - 1.8 - 2.3 and cross blade Ø 1.5)

TO-130/B4 Assortiment de 4 lames de rechange
Replacement blades (set of 4 pcs)



TOURNEVIS À MORILLE, avec manche ergonomique, chromé.
Lames de rechange : voir TO-120/B ci-dessus
SCREWDRIVERS WITH SCREW CHUCK, and ergonomic handle.
Chrome plated. Replacement of blades : see TO-120/B above

TO-185/A10	avec lame plate / with flat blade	Ø 1,0 mm
TO-185/A15	avec lame plate / with flat blade	Ø 1,5 mm
TO-185/A18	avec lame plate / with flat blade	Ø 1,8 mm
TO-185/A23	avec lame plate / with flat blade	Ø 2,3 mm
TO-186/A15	avec lame cruc. / with cross blade	Ø 1,5 mm
TO-186/A20	avec lame cruc. / with cross blade	Ø 2,0 mm
TO-186/A25	avec lame cruc. / with cross blade	Ø 2,5 mm

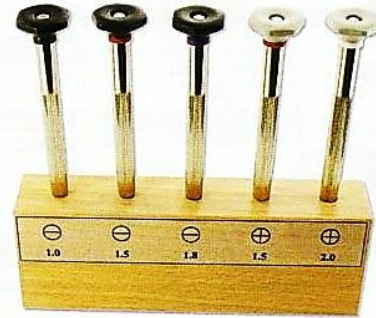

TO-119 ASSORTIMENT TOURNEVIS à tête large en plastique, comprenant :
SET OF SCREWDRIVERS with large plastic head including :

Tournevis **TO-120/A10, TO-120/A15, TO-120/A18, TO-121/A15, TO-121/A20**
Screwdrivers **TO-120/A10, TO-120/A15, TO-120/A18, TO-121/A15, TO-121/A20**

TO-119/1 Socle bois seul
Wood support only

LAMES DE RECHANGE
POUR TO-120, TO-121, TO-130, TO-175 ET TO-176 (3 pcs)
REPLACEMENT BLADES
FOR TO-120, TO-121, TO-130, TO-175 AND TO-176 (3 pcs)

TO-120/B10		Plate / Flat Ø 1,0
TO-120/B15		Plate / Flat Ø 1,5
TO-120/B18		Plate / Flat Ø 1,8
TO-120/B23		Plate / Flat Ø 2,3
TO-121/B15		Cruciforme / Cross Ø 1,5
TO-121/B20		Cruciforme / Cross Ø 2,0
TO-121/B25		Cruciforme / Cross Ø 2,5



TO-190 TOURNEVIS manche plastique noir avec 4 lames
(plates 1,5 - 1,8 et cruciforme 1,5 - 1,8) - serrage : 2,5

SCREWDRIVER with black plastic handle with 4 blades
(flat 1.6 - 1.8 and cross 1.5 - 1.8 mm) - capacity : 2.5.

Lames de rechange pour TO-190 (3 pcs)
Replacement blades for TO-190 (3 pcs)

TO-190/B16	plate / flat Ø 1,6 mm
TO-190/B18	plate / flat Ø 1,8 mm
TO-191/B15	cruciforme / cross Ø 1,5 mm
TO-191/B18	cruciforme / cross Ø 1,8 mm

Tournevis

Screwdrivers



TO-178 ASSORTIMENT DE TOURNEVIS À MORILLE
manches simples, coffret bois, comprenant :
TO-175/A10 à TO-175/A18,
TO-176/A15, TO-176/A20
SET OF SIMPLE SCREWDRIVERS WITH
SCREW CHUCK and simple handles,
wooden storage box, including :
TO-175/A10 to TO-175/A18,
TO-176/A15, TO-176/A20

TO-177 ASSORTIMENT DE TOURNEVIS À MORILLE
manches simples, support bois, comprenant :
TO-175/A10 à TO-175/A18,
TO-176/A15, TO-176/A20
SET OF SCREWDRIVERS WITH SCREW CHUCK
and simple handles, wooden support, including :
TO-175/A10 to TO-175/A18,
TO-176/A15, TO-176/A20

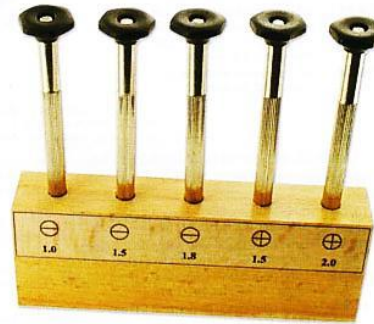

TOURNEVIS À MORILLE, manche simple.
Lames de rechange : voir TO-120/B en page 32
SCREWDRIVER WITH SCREW CHUCK, simple handle.
Replacement of blades : see TO-120/B page 32

- TO-175/A10** avec lame plate / with flat blade Ø 1,0 mm
- TO-175/A15** avec lame plate / with flat blade Ø 1,5 mm
- TO-175/A18** avec lame plate / with flat blade Ø 1,8 mm
- TO-175/A23** avec lame plate / with flat blade Ø 2,3 mm
- TO-176/A15** avec lame cruc. / with cross blade Ø 1,5 mm
- TO-176/A20** avec lame cruc. / with cross blade Ø 2,0 mm
- TO-176/A25** avec lame cruc. / with cross blade Ø 2,5 mm



TO-180/A20 TOURNEVIS lame plate extra-longue
SCREWDRIVER extra-long flat blade

TO-180/B20 LAMES plates extra-longues (3 pcs)
Extra-long flat BLADES (3 pcs)



TO-181/A20 TOURNEVIS lame cruciforme extra-longue
SCREWDRIVER extra-long cross blade

TO-181/B20 LAMES plates extra-longues (3 pcs)
Extra-long cross BLADES (3 pcs)

Tournevis - Clés

Screwdrivers - Wrenches

TO-172 ASSORTIMENT DE TOURNEVIS ET CLÉS POUR ÉCROUS, avec manche ergonomique, chromé. En coffret plastique, comprenant : SET OF SCREWDRIVERS AND NUT WRENCHES, with ergonomic handle, chrome plated. In plastic case including :

- TO-170/A10** : tournevis lame plate Ø 1,0
screwdriver with flat blade Ø 1.0
- TO-170/A15** : tournevis lame plate Ø 1,5
screwdriver with flat blade Ø 1.5
- TO-170/A18** : tournevis lame plate Ø 1,8
screwdriver with flat blade Ø 1.8
- TO-170/A23** : tournevis lame plate Ø 2,3
screwdriver with flat blade Ø 2.3
- TO-171/A15** : tournevis lame cruciforme Ø 1,5
screwdriver with cross blade Ø 1.5
- TO-171/A20** : tournevis lame cruciforme Ø 2,0
screwdriver with cross blade Ø 2.0
- CL-110/A0** : clé pour écrou étoile de 2,2
wrench for 2.2 star nut
- CL-110/A1** : clé pour écrou hexagonal de 2,2
wrench for 2.2 hexagonal nut
- CL-110/A3** : clé pour écrou étoile de 2,8
wrench for 2.8 star nut
- CL-110/A4** : clé pour écrou étoile de 2,5
wrench for 2.5 star nut



LAMES DE RECHANGE (pour CL-110/A0 à A4) REPLACEMENT BLADES (for CL-110/A0 to A4)

- CL-110/B0** : lame pour écrou étoile de 2,2 (1 pc)
blade for 2.2 star nut (1 pc)
- CL-110/B1** : lame pour écrou hexagonal de 2,2 (1 pc)
blade for 2.2 hexagonal nut (1 pc)
- CL-110/B3** : lame pour écrou étoile de 2,8 (1 pc)
blade for 2.8 star nut (1 pc)
- CL-110/B4** : lame pour écrou étoile de 2,5 (1 pc)
blade for 2.5 star nut (1 pc)
- CL-110/B5** : lame pour écrou hexagonal de 2,5 (1 pc)
blade for 2.5 hexagonal nut (1 pc)



TOURNEVIS avec manche ergonomique, chromé
SCREWDRIVERS with ergonomic handle, chrome plated

- TO-170/A10** avec lame plate / with flat blade Ø 1,0 mm
- TO-170/A15** avec lame plate / with flat blade Ø 1,5 mm
- TO-170/A18** avec lame plate / with flat blade Ø 1,8 mm
- TO-170/A23** avec lame plate / with flat blade Ø 2,3 mm
- TO-171/A15** avec lame cruc. / with cross blade Ø 1,5 mm
- TO-171/A20** avec lame cruc. / with cross blade Ø 2,0 mm
- TO-171/A25** avec lame cruc. / with cross blade Ø 2,5 mm

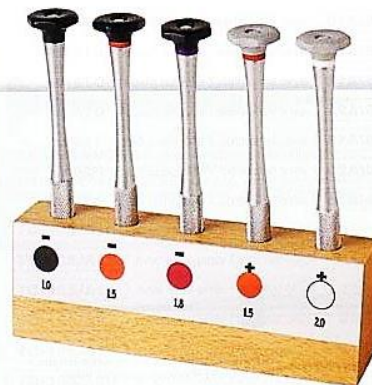

Lames pour TO-170 et TO-171 = voir TO-120/B page 32
Blades for TO-170 and TO-171 = see TO-120/B page 32

TO-169 ASSORTIMENT TOURNEVIS, avec manche ergonomique, chromé comprenant : SET OF SCREWDRIVERS, with ergonomic handle, chrome plated, including :
TO-170/A10, TO-170/A15, TO-170/A18, TO-171/A15, TO-171/A20

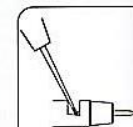

Changement de la lame à l'aide d'un gros tournevis

Blade replacement thanks to a large screwdriver

Tournevis Screwdrivers



Les tournevis préhensibles sont équipés d'une lame rétractable et de mâchoires ressorts s'auto-ajustant. Ils permettent de tenir les vis pendant l'opération de vissage ou de dévissage.

Pick-up screwdrivers are equipped with a retractable blade and self-adjusting spring jaws. Used for holding screws when screwing up or unscrewing.



TO-749 TOURNEVIS PRÉHENSIBLE lame plate Ø 1,0 mm
PICK-UP SCREWDRIVER flat blade Ø 1.0 mm



TO-750 TOURNEVIS PRÉHENSIBLE lame plate Ø 1,5 mm
PICK-UP SCREWDRIVER flat blade Ø 1.5 mm



TO-747 TOURNEVIS PRÉHENSIBLE lame plate Ø 2,0 mm
PICK-UP SCREWDRIVER flat blade Ø 2.0 mm



TO-748 TOURNEVIS PRÉHENSIBLE lame cruciforme Ø 2,0 mm
PICK-UP SCREWDRIVER cross blade Ø 2.0 mm

PIÈCES DE RECHANGE (sachet 1 pièce)
REPLACEMENT PARTS (bag of 1 piece)



Lame
Blade

⊖	Ø 1.0	TO-749/1
⊖	Ø 1.5	TO-750/1
⊖	Ø 2.0	TO-747/1
⊕	Ø 2.0	TO-748/1



Lame + ressort
Blade + spring

⊖	Ø 1.0	TO-749/4
⊖	Ø 1.5	TO-750/4
⊖	Ø 2.0	TO-747/4
⊕	Ø 2.0	TO-748/4

TOURNEVIS DE POCHE - 3 fonctions :
1 lame plate Ø 2 mm + 1 lame cruciforme Ø 2 mm
+ 1 clé pour écrous étoile de 2,5 mm.
(sachet de 10 pcs)
POCKET SCREWDRIVER - 3 functions :
1 flat blade Ø 2 mm + 1 cross blade Ø 2 mm
+ 1 blade for star nuts of 2.5 mm
(bag of 10 pcs)

TO-166 Doré / Gold plated

TO-167 Nickelé / Nickel plated

TOURNEVIS DE POCHE
une lame plate Ø 1,6 mm (sachet de 10 pcs)
POCKET SCREWDRIVER
Flat blade Ø 1.6 mm (bag of 10 pcs)

TO-159 Doré / Gold plated

TO-160 Nickelé / Nickel plated

Accessoires Accessories



PI-055
OUTIL À AFFÛTER LES LAMES DE TOURNEVIS
(en coffret bois avec pierre)
SCREWDRIVER SHARPENER
(in wooden box with grinding stone)

GAINES RÉTRACTABLES
pour tournevis et divers
autres outils pour la décoration,
le confort et la protection
Sachet de 5 pcs
HEAT SHRINK SLEEVES for
screwdrivers and other tools, for
decoration, comfort and protection
Bag of 5 pcs

TO-254/05 Rouge / Red

TO-255/05 Bleu / Blue

TO-256/05 Jaune / Yellow

TO-257/05 Vert / Green

TO-250/08 Assortiment 2 pcs de chaque couleur
Set of 2 pcs of each colour



Tournevis - Clés

Screwdrivers - Wrenches



- 1 TO-110** ASSORTIMENT DE TOURNEVIS en coffret bois :
SET OF SCREWDRIVERS in wooden storage box :
- Contenu identique à l'assortiment TO-102
 - Same tools and blades as TO-102

- 2 TO-216** ASSORTIMENT DE TOURNEVIS ET CLÉS en coffret bois :
SET OF SCREWDRIVERS AND WRENCHES in wooden storage box :
- Contenu identique à l'assortiment TO-215
 - Same tools as TO-215



Assortiments de tournevis et clés

Sets of screwdrivers and wrenches

- TO-102** ASSORTIMENT DE TOURNEVIS sur socle tournant comprenant :
SET OF SCREWDRIVERS on rotating stand including :
- 9 tournevis à lame plate du TO-102/A06 au TO-102/A30 + lames de rechange
 - 9 screwdrivers with flat blades from TO-102/A06 to TO-102/A30 + replacement blades

- TO-215** ASSORTIMENT DE TOURNEVIS ET CLÉS sur socle tournant comprenant :
SET OF SCREWDRIVERS AND WRENCHES on rotating stand including :
- 1 pointe à tracer / 1 scriber
 - 2 tournevis à lames cruciformes / 2 cross blade screwdrivers 1.5 - 2.0
 - 4 tournevis à lames plates / 4 flat blade screwdrivers 1.2 - 1.4 - 1.6 - 2.0
 - 2 tourne-écrous / 2 nut wrenches 2.2 - 2.5

Accessoires / Accessories

TOURNEVIS ET LAMES DE RECHANGE pour TO-102 et TO-110
REPLACEMENT SCREWDRIVERS AND BLADES for TO-102 and TO-110

Diamètre Diameter	Couleur Colour	Tournevis Screwdriver	Lames (3 pcs) Blades (3 pcs)
0,6	Rose / Pink	TO-102/A06	TO-102/B06
0,8	Jaune / Yellow	TO-102/A08	TO-102/B08
1,0	Noir / Black	TO-102/A10	TO-102/B10
1,2	Rouge / Red	TO-102/A12	TO-102/B12
1,4	Gris / Grey	TO-102/A14	TO-102/B14
1,6	Violet / Violet	TO-102/A16	TO-102/B16
2,0	Vert / Green	TO-102/A20	TO-102/B20
2,5	Bleu / Blue	TO-102/A25	TO-102/B25
3,0	Brun / Brown	TO-102/A30	TO-102/B30

- TO-102/C** VIS DE FIXATION DES LAMES POUR TOURNEVIS (du TO-102/A06 au TO-102/A30 et du TO-115/060 au TO-115/300) - Sachet de 10 pièces
FIXING SCREWS OF BLADES FOR SCREWDRIVERS (from TO-102/A06 to TO-102/A30 and from TO-115/060 to TO-115/300) - Bag of 10 pieces

OUTILS ET LAMES DE RECHANGE pour TO-215 et TO-216
REPLACEMENT TOOLS AND BLADES for TO-215 and TO-216

	Outil Tool	Lame (3 pcs) Blade (3 pcs)
Pointe à tracer / Scriber	TO-115/060	TO-115/061
Tournevis cruciforme Ø 1,5 Cross blade screwdriver Ø 1.5	TO-215/080	TO-215/081
Tournevis cruciforme Ø 2,0 Cross blade screwdriver Ø 2.0	TO-215/100	TO-215/101
Tournevis / Screwdriver Ø 1,2	TO-102/A12	TO-102/B12
Tournevis / Screwdriver Ø 1,4	TO-102/A14	TO-102/B14
Tournevis / Screwdriver Ø 1,6	TO-102/A16	TO-102/B16
Tournevis / Screwdriver Ø 2,0	TO-102/A20	TO-102/B20

	Outil Tool	Lame (1 pc) Blade (1 pc)
Clé pour écrous hexagonaux Ø 2,2 Hexagonal nut wrench 2.2	TO-115/250	TO-115/251
Clé pour écrous étoile de 2,5 Star nut wrench 2.5	TO-115/300	TO-115/301

Tournevis - Clés

Screwdrivers - Wrenches



TO-220 ASSORTIMENT DE TOURNEVIS, CLÉS POUR ÉCROUS ET BAGUES DE VISSAGE, comprenant :
SET OF SCREWDRIVERS, NUT WRENCHES AND SCREWING RINGS, including :

5 manches / 5 handles

10 lames / 10 blades :

- 2 lames plates / 2 flat blades : 1.5 - 1.7
- 2 lames cruciformes / 2 cross blades : 1.5 - 1.7
- 6 clés pour écrou / 6 nut wrenches : étoiles / star 2.5 - 2.8, hexagonales / hexagonal 2.0 - 2.3 - 2.5, carrée / square 2.2

5 bagues de vissage / 5 screwing rings :

- hexagonales / hexagonal : 2.0 - 2.3 - 2.5
- lame plate / flat blade : 1.8
- lame cruciforme / cross blade : 1.8



OUTILS ET LAMES DE RECHANGE pour TO-220
TOOLS AND REPLACEMENT BLADES for TO-220

Description Description	Manche + lame Handle + blade	Lames de rechange (quantité) Replacement blades (quantity)
Lame plate / Flat blade 1.5	TO-220/A1	TO-220/B1 (3 Pcs)
Lame plate / Flat blade 1.7	TO-220/A2	TO-220/B2 (3 Pcs)
Lame cruciforme / Cross blade 1.5	TO-220/A3	TO-220/B3 (3 Pcs)
Lame cruciforme / Cross blade 1.7	TO-220/A4	TO-220/B4 (3 Pcs)
Clé étoile / Star wrench 2.5	TO-220/A6	TO-220/B6 (1 Pc)
Clé étoile / Star wrench 2.8	TO-220/A7	TO-220/B7 (1 Pc)
Clé hexagonale / Hexagonal wrench 2.0	TO-220/A8	TO-220/B8 (1 Pc)
Clé hexagonale / Hexagonal wrench 2.3	TO-220/A9	TO-220/B9 (1 Pc)
Clé hexagonale / Hexagonal wrench 2.5	TO-220/A11	TO-220/B11 (1 Pc)
Clé carrée / Square wrench	TO-220/A10	TO-220/B10 (1 Pc)

BA-200 ASSORTIMENT DE 5 BAGUES DE VISSAGE
Se mettent à un doigt pour bloquer un côté du couple vis/écrou pendant le travail de l'autre côté.
Comprenant :
SET OF 5 SCREWING RINGS
To be slipped on on a finger in order to block one side of the screw/nut couple while working on the other side. Including :

- hexagonales / hexagonal : 2.0 - 2.3 - 2.5
- lame plate / flat blade : 1.8
- lame cruciforme / cross blade : 1.8



Appareils à ultrasons

Ultrasonic devices



2 AP-109

APPAREIL A ULTRASONS avec chauffage pour l'atelier.
 Température réglable de 30 à 80° C. Performances élevées et très grande fiabilité. Livré sans couvercle et sans panier.
 Minuterie réglable de 0 à 30 minutes.
 Dimensions intérieures de la cuve : 240 x 137 x 100 mm
 Capacité : 2,75 litres. Fréquence : 37 KHz
 Puissance 75 watts - 220/240 volts - Poids : 3,4 kg.

ULTRASONIC DEVICE with heating for workshop.
 Temperature adjustable from 30 to 80° C. High performances and very high reliability. Delivered without lid and without basket.
 Timer adjustable from 0 to 30 minutes.
 Inner dimensions of the tank : 240 x 137 x 100 mm.
 Capacity : 2,75 liters. Frequency : 37 KHz
 Power : 75 watts - 220/240 volts - Weight : 3.4 kg.

OPTIONS :

1 AP-109/1 Couvercle en plastique pour AP-109
 Plastic LID for AP-109

3 AP-109/2 Panier en acier inoxydable pour AP-109
 Stainless steel BASKET for AP-109



AP-110

PRODUIT UNIVERSEL POUR DÉGRAISSAGE DE TOUTES PIÈCES.
 Produit concentré à diluer : 10 % de produit, 90 % d'eau.
 Efficacité maximale dans l'eau entre 40 et 50° C.
 (1 litre de produit concentré)
CLEANING SOLUTION FOR ALL PARTS.
 Concentrated product to dilute : 10 % of product, 90 % of water.
 Maximal efficiency in water from 40 to 50° C.
 (1 liter of concentrated solution)



4 AP-106

APPAREIL A ULTRASONS pour magasin.
 Système d'oscillation en sandwich à large diffusion. Grande fiabilité.
 Livré avec couvercle mais sans panier.
 Minuterie réglable de 0 à 30 minutes.
 Dimensions intérieures de la cuve : 190 x 85 x 60 mm
 Capacité : 0,8 litre. Fréquence : 37 KHz
 Puissance 30 watts - 220/240 volts - Poids : 2,0 kg.

ULTRASONIC DEVICE for store.
 Sandwiched oscillation system with large diffusion. High reliability.
 Delivered with a lid but without basket.
 Timer adjustable from 0 to 30 minutes.
 Inner dimensions of the tank : 190 x 85 x 60 mm. Capacity : 0.8 liter.
 Frequency : 37 KHz
 Power : 30 watts - 220/240 volts - Weight : 2.0 kg.

5 AP-107

APPAREIL A ULTRASONS
 même que AP-106 mais avec chauffage.
ULTRASONIC DEVICE
 same as AP-106 but with heating.

6 AP-106/2

Panier en acier inoxydable pour AP-106 et AP-107
 Stainless steel basket for AP-106 and AP-107

Potenza new Ventilettes

Star Frame heaters



VE-109 ▲

VENTILETTE "PASSAT"

Teinte : blanc

Avec réglage de température de 75 à 180°C

Contrôle électronique

Livrée avec un concentrateur d'air pour chauffage localisé (VE-109/3)

220/240 volts - Poids : 1,8 kg - Dimensions : 100x225x150

FRAME HEATER "PASSAT"

Colour : white

With temperature adjustment from 75 to 180°C

Electronically controlled

Delivered with a heat concentrator for localized heating (VE-109/3)

220/240 volts - Weight : 1,8 kg - Size : 100x225x150



VE-107 ▲

VENTILETTE "VISPA UP"

Température de chauffe ~ 120°C

Livrée avec un concentrateur d'air pour

chauffage localisé (VE-106/3)

220/240 volts - Poids : 1,9 kg - Dimensions : 110x100x270

AIR FRAME HEATER "VISPA UP"

Heating temperature ~ 120°C

Supplied with a heat concentrator (VE-106/3)

220/240 volts - Weight : 1.9 kg - Size : 110x100x270



VE-112

VENTILETTE DIGITALE

avec affichage digital en temps réel de la température

de travail à l'intérieur du boîtier.

600 watts - Température : 40/150°C

220/240 volts - Poids 1,66 kg - Dimensions : 235x125x250

DIGITAL FRAME HEATER

Display the real-time work temperature inside the housing

600 watts - Temperature : 40/150°C

220/240 volts - Weight : 1.66 kg - Size : 235x125x250

VE-108

VENTILETTE "ZITA PLUS"

Deux niveaux de température (60°C/100°C - 110°C/150°C)

Régulateur de chaleur électronique

Ne provoque pas de brûlure à la monture

Peut être encastrée dans le plan de travail

220/240 volts - Poids : 1,8 kg - Dimensions : 144x200x213

FRAME HEATER "ZITA PLUS"

Two temperature levels (60°C/100°C - 110°C/150°C)

Electronic heating regulator

Prevents from burning the frame

Can be inserted into the bench

220/240 volts - Weight : 1.8 kg - Size : 144x200x213

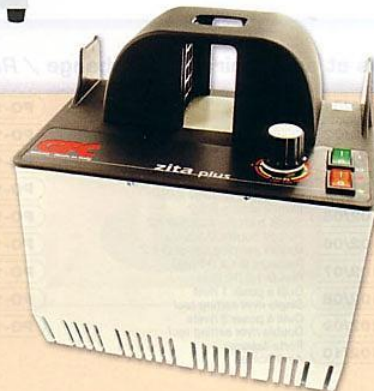



Vis de tenons et de charnières

Closing block and hinge screws

Vis en maillechort

Nickel silver screws

TYPE DE PRODUIT PRODUCT TYPE			REFERENCE / STOCK NUMBER Sachet de 100 pièces / Bag of 100 pcs		
	d	D	Blanc / White	Doré / Gold	
	1,2	2,5	3,7	VI-160/C	-
	1,2	2,0	4,5	VI-161/C	VI-161/DC
	1,4	1,8	3,4	-	VI-902/NC ⁽¹⁾
	1,4	1,9	3,4	VI-046/C	VI-046/DC
	1,4	1,9	3,8	VI-047/C	VI-047/DC
	1,4	1,8	4,4	-	VI-904/NC ⁽¹⁾
	1,4	1,9	4,4	VI-048/C	VI-048/DC
	1,4	1,9	5,0	VI-050/C	VI-050/DC
	1,4	1,9	5,4	VI-051/C	-
	1,4	1,9	5,8	VI-052/C	VI-052/DC
	1,4	1,9	6,8	VI-053/C	VI-053/DC
	1,4	2,8	2,8	VI-911/C	-
	1,4	2,8	3,3	VI-912/C	-
	1,4	2,5	5,2	VI-055/C	VI-055/DC
	1,4	2,5	5,8	VI-056/C	-
	1,4	2,5	6,2	VI-057/C	-
	1,4	2,5	8,0	VI-059/C	-
	1,6	2,5	5,2	VI-909/C	VI-909/DC
	1,6	2,5	5,8	VI-910/C	-

(1) Vis noircies / Black colour screws

Vis en laiton

Brass screws

TYPE DE PRODUIT PRODUCT TYPE			REFERENCE / STOCK NUMBER Sachet de 100 pièces / Bag of 100 pcs		
	d	D	Blanc / White	Doré / Gold	
	1,4	1,9	7,0	VI-487/C	-
	1,4	2,5	7,0	VI-495/C	-

ASSORTIMENTS DE VIS SCREW SETS



CASE	RÉFÉRENCE STOCK Nr	QUANT. QUANT.
1	VI-046	100
2	VI-047	90
3	VI-048	80
4	VI-050	70
5	VI-052	60
6	VI-053	50
7	VI-055	80
8	VI-056	65
9	VI-057	60
10	VI-059	45
11	EC-100	100

VI-100 ASSORTIMENT DE VIS ET D'ÉCROUS en maillechort comprenant :
SET OF NICKEL SILVER SCREWS AND NUTS including :

• Voir tableau ci-dessus
See above board



CASE	RÉFÉRENCE STOCK Nr	QUANT. QUANT.
1	VI-049/D	100
2	VI-046/D	85
3	VI-047/D	80
4	VI-048/D	75
5	VI-050/D	60
6	VI-053/D	50
7	VI-055/D	60
8	VI-062/D	45
9	VI-060/D	35
10	EC-097/D	100
11	EC-100/D	100

VI-110 ASSORTIMENT DE VIS ET D'ÉCROUS en maillechort doré comprenant :
SET OF NICKEL SILVER SCREWS AND NUTS gold plated including :

• Voir tableau ci-dessus
See above board

EX-200 EXTRACTEUR DE VIS CASSÉES BROKEN SCREW EXTRACTOR



Voir aussi page 38
see also page 38

Vis Screws



VI-101 ASSORTIMENT DE VIS EN ACIER INOXYDABLE ET D'ECROUS EN MAILLECHORT comprenant : SET OF STAINLESS STEEL SCREWS AND SILVER NICKEL NUTS including :

• Voir tableau ci-dessous / See below board

CASE	RÉFÉRENCE STOCK N°	QUANT. QUANT.
1	VI-075	100
2	VI-076	90
3	VI-074	75
4	VI-900	80
5	VI-901	75
6	VI-073	75
7	VI-077	55
8	VI-080	55
9	VI-081	55
10	EC-097	80
11	EC-100	100



Vis en acier inoxydable Stainless steel screws

TYPE DE PRODUIT PRODUCT TYPE	REFERENCE / STOCK NUMBER (Sachet de 100 pièces / Bag of 100 pieces)				
	d	D	L		
	1,2	1,7	3,2	Blanc / White	Doré / Gold
	1,2	1,6	4,3	VI-076/C	VI-074/DC
	1,2	1,8	10,6	VI-074/C	VI-069/DC
	1,4	1,9	2,7	VI-069/C	VI-900/DC
	1,4	2,0	2,7	VI-900/C	VI-901/DC
	1,4	1,9	3,4	VI-901/C	VI-070/DC
	1,4	1,8	4,3	VI-070/C	VI-073/DC
	1,4	1,8	4,3	VI-073/C	VI-073/DC
	1,4	1,9	4,8	VI-077/C	-
	1,4	1,9	7,0	VI-387/C	VI-387/DC
	1,4	1,8	10,6	VI-071/C	VI-071/DC
	1,4	2,5	2,8	VI-080/C	-
	1,4	2,5	3,8	VI-081/C	-
	1,4	2,5	7,0	VI-395/C	VI-395/DC
	1,6	2,5	10	VI-072/C	VI-072/DC

Vis spéciales en acier inoxydable Stainless steel special screws

	TYPE DE PRODUIT PRODUCT TYPE	QUANTITE QUANTITY	REFERENCE / STOCK NUMBER				
			d	D	L		
Vis avec tête ronde striée sous tête Round head screw scratched under head		25	1,2	1,6	10,5	Blanc / White	Doré / Gold
			1,4	1,8	10,5	VI-930/25	VI-930/D25
Vis tête étoilée Star head screw		25	1,2	2,3	10,5	VI-932/25	VI-932/D25
			1,4	2,3	10,5	VI-940/25	VI-940/D25
Vis tête hexagonale Hexagonal head screws		25	1,2	2,0	8,5	VI-942/25	VI-942/D25
			1,2	2,0	8,5	VI-945/25	VI-945/D25
			1,4	2,6	8,8	-	VI-945/N25 ⁿ
(*) Gun		25	1,4	2,6	8,8	-	VI-947/D25
Vis tête étoile 5 branches 5 point star head screws		25	1,4	-	8,5	-	VI-947/N25 ⁿ
			1,4	-	8,5	VI-950/25	VI-950/D25

	TYPE DE PRODUIT PRODUCT TYPE	QUANTITE QUANTITY	REFERENCE / STOCK NUMBER				
			d	D	L		
Vis crantées sous tête Screws notched under head		50	1,3	1,8	4,8	Blanc / White	Doré / Gold
			1,4	2,0	3,0	VI-920/L	-
Vis avec bague plastique Screws with plastic bushing		50	1,4	2,0	3,0	VI-018-30/L	-
			1,4	2,0	3,5	VI-018-35/L	-
			1,4	2,0	4,0	VI-018-40/L	-
			1,4	2,0	4,5	VI-018-45/L	-
			1,6	2,5	3,5	VI-019/L	-

Vis de plaquettes en maillechort Nose pad nickel silver screws

TYPE DE PRODUIT PRODUCT TYPE				REFERENCE / STOCK NUMBER Sachet de 100 pièces / Bag of 100 pcs	
	d	D	L	Blanc / White	Doré / Gold
	0,8	1,0	3,7	VI-040/C	VI-040/DC
	1,0	1,4	4,1	VI-049/C	VI-049/DC
	1,1	1,3	4,2	VI-042/C	VI-042/DC

Vis de plaquettes en acier inoxydable Nose pad screws stainless steel

	1,0	1,4	4,1	VI-075/C	VI-075/DC
--	-----	-----	-----	----------	-----------

Vis filetées sous tête en maillechort Nickel silver screws threaded under head

	1,2	1,9	9,0	VI-155/C	VI-155/DC
	1,2	1,9	15	VI-156/C	VI-156/DC
	1,2	1,8	12	VI-065/C	VI-065/DC
	1,2	2,5	10	VI-062/C	VI-062/DC
	1,3	1,9	7,0	VI-088/C	VI-088/DC
	1,3	2,5	7,0	VI-094/C	VI-094/DC
	1,3	1,9	10	VI-061/C	VI-061/DC
	1,4	1,9	5,4	VI-090/C	VI-090/DC
	1,4	1,9	7,0	VI-087/C	VI-087/DC
	1,4	2,5	7,0	VI-095/C	VI-095/DC
	1,4	2,5	10,5	VI-060/C	VI-060/DC
	1,5	1,9	7,0	VI-088/C	VI-088/DC
	1,5	2,5	7,0	VI-096/C	VI-096/DC
	1,5	2,5	10	VI-063/C	VI-063/DC
	1,6	1,9	7,0	VI-089/C	VI-089/DC
	1,6	2,5	7,0	VI-097/C	VI-097/DC
	1,6	2,5	10	VI-064/C	VI-064/DC
	1,8	2,5	10	VI-066/C	VI-066/DC

Vis avec incrustation pierres (sachet de 10 pièces + écrous) Screws with stone inlay (bag of 10 pcs + nuts)

	d	D	L	Blanc White	Doré Gold	Teinte pierre Stone colour
				1,2	2,3	10
	1,16	2,3	10	VI-311/10	VI-311/D10	● Rouge / Red
	1,16	2,3	10	VI-312/10	VI-312/D10	● Bleu / Blue
	1,16	2,3	10	VI-313/10	VI-313/D10	● Vert / Green



CASE	RÉFÉRENCE STOCK N°	QUANT. QUANT.
1	VI-155	40
2	VI-155/D	40
3	VI-156	25
4	VI-156/D	25
5	TU-103	80
6	BA-120	50
7	RO-051	130
8	RO-060	65
9	RO-060/D	65
10	EC-111	65
11	EC-111/D	65
12	-	-

VI-115 ASSORTIMENT DE COMPOSANTS pour montages verres percés SET OF COMPONENTS for pierced lens mountings

* Voir tableau ci-dessus
See above board



CASE	RÉFÉRENCE STOCK N°	QUANT. QUANT.
1	VI-086	60
2	VI-086/D	60
3	VI-087	60
4	VI-087/D	60
5	VI-088	60
6	VI-088/D	60
7	VI-095	50
8	VI-095/D	50
9	VI-096	50
10	VI-096/D	50
11	VI-097	50
12	VI-097/D	50

VI-114 ASSORTIMENT DE VIS EN MAILLECHORT (blanches et dorées) comprenant : SET OF SILVER NICKEL SCREWS (white and gold) including :

* Voir tableau ci-dessus
See above board



CASE	RÉFÉRENCE STOCK N°	QUANT. QUANT.
1	VI-310	10
2	VI-310/D	10
3	VI-311	10
4	VI-311/D	10
5	VI-312	10
6	VI-312/D	10
7	VI-313	10
8	VI-313/D	10
9	RO-061	40
10	RO-061/D	40
11	RO-045	40
12	-	-

Case 1 à/à 2 : vis avec écrous de 1,2 / screws with nuts O 1.2
Case 3 à/à 8 : vis avec écrous de 1,16 / screws with nuts O 1.16

VI-106 ASSORTIMENT DE VIS avec incrustation pierres comprenant : SET OF SCREWS with stone inlay including :

* Voir tableau ci-dessus
See above board

Vis Screws

Vis spéciales Special screws

VIS FREIN-FILET AVEC FIL NYLON
SCREWS WITH LOCKING SYSTEM BY NYLON THREAD

VIS AUTO-TARAUEUSES
SELF-TAPPING SCREWS

VIS AUTO-CENTREUSES
SELF-CENTRING SCREWS



CASE	REFERENCE STOCK Nr	QUANT. QUANT.
1	VI-122	25
2	VI-122/D	25
3	VI-123	25
4	VI-123/D	25
5	VI-124	25
6	VI-124/D	25
7	VI-133	25
8	VI-133/D	25
9	VI-134	25
10	VI-134/D	25
11	VI-135	25
12	VI-135/D	25

VI-119 ASSORTIMENT DE VIS "FREIN-FILET" en acier inoxydable avec système anti-desserrage par fil nylon incrusté le long de la tige de la vis. Blanc et doré (environ 300 vis) comprenant :
SET OF STAINLESS STEEL SCREWS with locking system, anti-releasing system by a nylon thread encrusted along the screw rod. White and gold (approx. 300 screws) including :

• Voir tableau ci-dessus / See above board



CASE	REFERENCE STOCK Nr	QUANT. QUANT.
1	VI-171	25
2	VI-171/D	25
3	VI-172	25
4	VI-172/D	25
5	VI-173	25
6	VI-173/D	25
7	VI-182	25
8	VI-182/D	25
9	VI-183	25
10	VI-183/D	25
11	VI-184	25
12	VI-184/D	25

VI-116 ASSORTIMENT DE VIS AUTO-TARAUEUSES en acier inoxydable. Blanc et doré (environ 300 vis) comprenant :
SET OF SELF-TAPPING SCREWS in stainless steel. White and gold (approx. 300 screws) including :

• Voir tableau ci-dessus / See above board



CASE	REFERENCE STOCK Nr	QUANT. QUANT.
1	VI-140	50
2	VI-140/D	50
3	VI-141	50
4	VI-141/D	50
5	VI-145	50
6	VI-145/D	50
7	VI-146	50
8	VI-146/D	50
9	-	-
10	-	-
11	-	-
12	-	-

VI-139 ASSORTIMENT DE VIS AUTO-CENTREUSES en acier inoxydable. Blanc et doré (environ 400 vis) comprenant :
SET OF SELF-CENTRING SCREWS in stainless steel. White and gold (approx. 400 screws) including :

• Voir tableau ci-dessus / See above board



	TYPE DE PRODUIT PRODUCT TYPE	*			QUANTITÉ QUANTITY	VIS EN ACIER INOXYDABLE SCREWS IN STAINLESS STEEL	
		d	D	L		Blanc / White	Doré / Gold
VIS FREIN-FILET / SCREWS WITH LOCKING SYSTEM		1,4	1,9	3,9	100	VI-022/C	-
		1,4	2,5	4,8	100	VI-026/C	-
		1,2	1,8	11	25	VI-121/25	VI-121/D25
		1,3	1,8	11	25	VI-122/25	VI-122/D25
		1,4	1,8	11	25	VI-123/25	VI-123/D25
		1,5	1,8	11	25	VI-124/25	VI-124/D25
		1,3	2,8	11	25	VI-132/25	VI-132/D25
		1,4	2,8	11	25	VI-133/25	VI-133/D25
		1,5	2,8	11	25	VI-134/25	VI-134/D25
		1,6	2,8	11	25	VI-135/25	VI-135/D25

VIS AUTO-TARAUEUSES / SELF-TAPPING SCREWS		1,3	1,9	11	50	VI-171/L	VI-171/DL
		1,4	1,9	11	50	VI-172/L	VI-172/DL
		1,5	1,9	11	50	VI-173/L	VI-173/DL
		1,3	2,8	11	50	VI-181/L	VI-181/DL
		1,4	2,8	11	50	VI-182/L	VI-182/DL
		1,5	2,8	11	50	VI-183/L	VI-183/DL
		1,6	2,8	11	50	VI-184/L	VI-184/DL

VIS AUTO-CENTREUSES / SELF-CENTRING SCREWS		1,2	2,0	3,5	100	VI-140/C	VI-140/DC
		1,2	2,0	4,0	100	VI-141/C	VI-141/DC
		1,4	2,0	3,5	100	VI-145/C	VI-145/DC
		1,4	2,0	4,0*	100	VI-146/C	VI-146/DC

* L = Longueur fileté / Threaded length

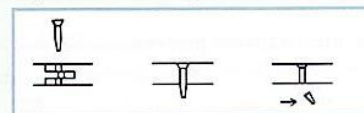

VIS AUTO-CENTREUSES en acier inoxydable, facilitant le montage des charnières flexibles. Casse facilement de la longueur en excès.
SELF-CENTRING SCREWS in stainless steel, for an easier mounting of flexible hinges. Easy breaking of exceeding length.

Vis - Vis d'essai

Screws - Eyewire sizing screws



TYPE DE PRODUIT PRODUCT TYPE	REFERENCE / STOCK NUMBER (Sachet de 100 pièces / Bag of 100 pieces) Acier inoxydable / Stainless steel				
	Blanc / White Doré / Gold				
	d	D	L		
	1,0	1,7	4,5	VI-404/C	VI-404/DC
	1,1	1,7	4,2	VI-414/C	VI-414/DC
	1,2	2,5	10	VI-420/C	VI-420/DC
	1,4	2,0	4	VI-444/C	VI-444/DC
	1,4	2,0	5	VI-445/C	VI-445/DC
	1,4	2,5	5	VI-455/C	VI-455/DC
	1,4	2,5	10	VI-460/C	VI-460/DC



Vis têtes cruciformes avec enduction plastique de la tige, évitant le dévissage
Cross head screws with plastic coating of the shank avoiding the unscrewing

TYPE DE PRODUIT PRODUCT TYPE	REFERENCE / STOCK NUMBER (Sachet de 100 pièces / Bag of 100 pieces) Acier inoxydable / Stainless steel				
	Blanc / White Doré / Gold				
	d	D	L		
	1,2	2,5	10	VI-420/PC	VI-420/DPC
	1,4	2,0	4	VI-444/PC	VI-444/DPC
	1,4	2,0	5	VI-445/PC	VI-445/DPC
	1,4	2,5	5	VI-455/PC	VI-455/DPC
	1,4	2,5	10	VI-460/PC	VI-460/DPC

TYPE DE PRODUIT PRODUCT TYPE	REFERENCE / STOCK NUMBER			QUANTITE QUANT.		
	Maillechort / Nickel Silver					
	d	D	L			
	1,27	1,7	3,4	100	VI-010/C	VI-010/DC
	1,16	1,6	3,5	100	VI-011/C	VI-011/DC

	M 1,2	VI-198
	M 1,3	VI-199
	M 1,4	VI-200
	M 1,5	VI-201
	M 1,6	VI-202

Vis - Vis d'essai

Vis têtes cruciformes
Cross head screws



CASE	RÉFÉRENCE STOCK Nr	QUANT. QUANT.
1	VI-420	25
2	VI-420/D	25
3	VI-444	90
4	VI-444/D	90
5	VI-445	85
6	VI-445/D	85
7	VI-455	75
8	VI-455/D	75
9	VI-460	25
10	VI-460/D	25
11	EC-097 + D	50 + 50
12	EC-100 + D	50 + 50

VI-117 ASSORTIMENT DE VIS CRUCIFORMES
 en acier inoxydable comprenant :
 SET OF CROSS HEAD SCREWS in
 stainless steel including :

- Voir tableau ci-dessus / See above board



CASE	RÉFÉRENCE STOCK Nr	QUANT. QUANT.
1	VI-420/P	25
2	VI-420/DP	25
3	VI-444/P	90
4	VI-444/DP	90
5	VI-445/P	85
6	VI-445/DP	85
7	VI-455/P	75
8	VI-455/DP	75
9	VI-460/P	25
10	VI-460/DP	25
11	EC-097 + D	50 + 50
12	EC-100 + D	50 + 50

VI-118 ASSORTIMENT DE VIS CRUCIFORMES
 en acier inoxydable comprenant :
 SET OF CROSS HEAD SCREWS in
 stainless steel including :

- Voir tableau ci-dessus / See above board

Vis au pas américain
Screws at American pitch

◀ VIS / SCREWS
 Bausch et Lomb (Ray Ban)

Vis d'essai
Eyewire sizing screws



Tige en acier inoxydable
 Shank in stainless steel

Permet de faire l'essai
 du verre dans une monture
 métallique

For testing the lens in
 a metal frame

Rondelles, bagues, capuchons

Washers, bushings, caps

RO-090 ASSORTIMENT DE RONDELLES ET BAGUES PLASTIQUE SET OF PLASTIC WASHERS AND BUSHINGS

CASE	RÉFÉRENCE STOCK N°	QUANT. QUANT.
1	RO-045	100
2	RO-051	100
3	RO-047	100
4	RO-047/B	100
5	RO-048	100
6	RO-049	100
7	RO-044	100
8	BA-120	100
9	BA-122	100
10	BA-125	100
11	BA-119	100
12	BA-124	100

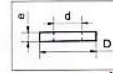

RO-091 ASSORTIMENT DE RONDELLES METAL SET OF METAL WASHERS

CASE	RÉFÉRENCE STOCK N°	QUANT. QUANT.
1	RO-061	100
2	RO-061/D	100
3	RO-054	100
4	RO-054/D	100
5	RO-053	100
6	RO-053/D	100
7	RO-052	100
8	RO-052/D	100
9	RO-050	100
10	RO-050/D	100
11	RO-055	100
12	RO-055/D	100

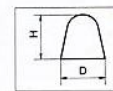
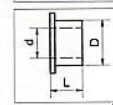
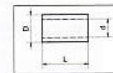

Rondelles / Washers

	Dimensions Size	Sachet de 100 pièces Bag of 100 pcs	
		Blanc / White	Doré / Gold
RONDELLES PLASTIQUES PLASTIC WASHERS	1,25 2,5 0,4	RO-045/C	-
	1,2 3,2 0,5	RO-051/C	-
	1,45 2,75 0,4	RO-047/C RO-047/CB	Cristal/Crystal Laituse/Milky
	1,5 3,0 0,5	RO-048/C	-
	1,6 3,0 0,5	RO-049/C	-
	1,6 3,2 0,5	RO-050/C	-
2,0 3,0 0,5	RO-044/C	-	-
RONDELLES METAL METAL WASHERS	1,2 2,2 0,2	RO-064/C	RO-064/DC
	1,25 2,5 0,4	RO-061/C	RO-061/DC
	1,3 2,5 0,4	RO-054/C	RO-054/DC
	1,4 2,2 0,2	RO-065/C	RO-065DC
	1,4 2,5 0,2	RO-066/C	RO-066/DC
	1,4 2,5 0,4	RO-053/C	RO-053/DC
	1,5 2,5 0,4	RO-052/C	RO-052/DC
	1,65 2,7 0,4	RO-062/C	RO-062/DC
1,85 2,9 0,4	RO-063/C	RO-063/DC	
RONDELLES CUVETTES CLIP METAL WASHERS	1,27 2,75 0,6	RO-060/C	RO-060/DC
	1,3 2,8 0,8	RO-055/C	RO-055/DC

Tubes et bagues épaulées en plastique Tubes and plastic bushings

	d	D	L	Sachet 100 pcs / Bag of 100 pcs	
TUBES PLASTIQUES PLASTIC TUBES	1,2	1,8	3,0	TU-103/C	-
	1,2	1,8	5,0	TU-105/C	-
BAGUES ÉPAULÉES PLASTIQUES PLASTIC BUSHINGS	1,2	1,8	1,3	BA-119/C	-
	1,25	1,65	1,9	BA-120/C	-
	1,32	2,05	1,3	BA-122/C	-
	1,4	1,9	1,3	BA-124/C	-
	1,4	1,75	2,0	BA-125/C	-

Bague épaulée en métal

diamètre 1,2, améliore l'articulation entre la charnière et la branche (sachet de 50 pièces)

Metal bushings

diameter 1.2, for improving the joint between hinge and temple (bag of 50 pieces)

BA-130/L



Capuchons / Caps

		D	h
CAPUCHON EN PLASTIQUE pour vis montages verres percés PLASTIC SCREW CAP for rimless mountings	M 1,2	CA-120/C	2,5 3,5
	M 1,4	CA-122/C	

Vis spéciales Special screws

Vis auto-centreuses Self-centring screws



CASE	REFERENCE STOCK N°	QUANT. QUANT.
1	VI-140	50
2	VI-140/D	50
3	VI-141	50
4	VI-141/D	50
5	VI-145	50
6	VI-145/D	50
7	VI-146	50
8	VI-146/D	50
9	VI-142	50
10	VI-142/D	50
11	VI-143	50
12	VI-143/D	50

VI-139 ASSORTIMENT DE VIS AUTO-CENTREUSES en acier inoxydable.
Blanc et doré (environ 600 vis) comprenant :
SET OF SELF-CENTRING SCREWS in stainless steel. White and gold (approx. 600 screws) including :

• Voir tableau ci-dessus / See above board

Vis auto-centreuses et bloquantes Self-centring and locking screws

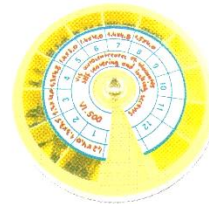

CASE	REFERENCE STOCK N°	QUANT. QUANT.
1	VI-501	25
2	VI-502	25
3	VI-503	25
4	VI-504	25
5	VI-505	25
6	VI-506	25
7	VI-508	25
8	VI-509	25
9	-	-
10	-	-
11	-	-
12	-	-

VI-500 ASSORTIMENT DE VIS AUTO-CENTREUSES ET BLOQUANTES en acier inoxydable.
(environ 200 vis) comprenant :
SET OF SELF-CENTRING AND LOCKING SCREWS in stainless steel.
(approx. 200 screws) including :

• Voir tableau ci-dessus / See above board



TYPE DE PRODUIT PRODUCT TYPE	L			QUANTITE QUANTITY	VIS EN ACIER INOXYDABLE SCREWS IN STAINLESS STEEL	
	d	D	L		Blanc / White	Doré / Gold
		1,2	2,0		3,5	100
	1,2	2,0	4,0	100	VI-141/C	VI-141/DC
	1,4	2,0	3,5	100	VI-145/C	VI-145/DC
	1,4	2,0	4,0*	100	VI-146/C	VI-146/DC
	1,3	2,0	3,5	100	VI-142/C	VI-142/DC
	1,5	2,0	3,5	100	VI-143/C	VI-143/DC







* L = Longueur fileté / Threaded length





VIS AUTO-CENTREUSES en acier inoxydable, facilitant le montage des charnières flexibles.
Casse facilement de la longueur en excès.
SELF-CENTRING SCREWS in stainless steel, for an easier mounting of flexible hinges.
Easy breaking of exceeding length.

TYPE DE PRODUIT PRODUCT TYPE	d	D	L	QUANTITE QUANTITY	REFERENCE STOCK NUMBER
		1,2	1,8	4,0	25
	1,3	2,0	3,5	25	VI-502/25
	1,3	1,8	4,0	25	VI-503/25
	1,3	1,8	4,8	25	VI-504/25
	1,4	1,8	3,0	25	VI-505/25
	1,4	1,8	4,0	25	VI-506/25
	1,4	2,0	4,8	25	VI-508/25
	1,5	1,8	4,0	25	VI-509/25

Écrous en maillechort / Nickel silver nuts

	Dimensions Size	Sachet de 100 pièces Bag of 100 pcs	
		d D L	Blanc / White Doré / Gold
ÉCROUS ÉTOILE STANDARDS STANDARD STAR NUTS		1,2 2,2 0,8	EC-097/C EC-097/DC
		1,3 2,2 0,8	EC-098/C EC-098/DC
		1,4 2,2 0,8	EC-100/C EC-100/DC
		1,4 2,5 1,0	EC-101/C EC-101/DC
		1,5 2,5 1,0	EC-102/C EC-102/DC
		1,6 2,5 1,0	EC-103/C EC-103/DC
ÉCROUS ÉTOILE BORGNES STAR CAP NUTS		1,2 2,2 2,1	EC-118/C EC-118/DC
		1,3 2,2 2,1	EC-119/C EC-119/DC
		1,4 2,2 2,2	EC-120/C EC-120/DC
		1,5 2,5 2,2	EC-121/C EC-121/DC
		1,6 2,5 2,2	EC-122/C EC-122/DC
ÉCROUS HEXAGONAUX STANDARDS STANDARD HEXAGONAL NUTS		1,2 2,25 1,0	EC-111/C EC-111/DC
		1,4 2,5 1,4	EC-114/C EC-114/DC
		1,4 2,5 1,4	noir/black EC-114/NC
ÉCROUS HEXAGONAUX BORGNES HEXAGONAL CAP NUTS		1,2 2,25 2,1	EC-116/C EC-116/DC
		1,4 2,55 2,6	EC-117/C EC-117/DC
BOMBÉS TRAVERSANTS OPEN BULGING NUTS		1,2 2,2 2,1	EC-148/C EC-148/DC
		1,4 2,2 2,1	EC-150/C EC-150/DC
ÉCROUS LONGS LONG NUTS		1,2 2,5 3,0	EC-140/C EC-140/DC
		1,2 2,5 5,0	EC-141/C EC-141/DC
		1,4 2,5 3,0	EC-142/C EC-142/DC
		1,4 2,5 5,0	EC-143/C EC-143/DC

Écrous en nylon cristal / Crystal nylon nuts

	Dimensions Size	Sachet de 100 pièces Bag of 100 pcs	
		d D L	
ÉTOILE STANDARDS STANDARD STAR NUTS		1,4 2,2 2,1	EC-160/C
ÉTOILE BORGNES STAR CAP NUTS		1,4 2,2 2,1	EC-170/C

Écrous en laiton / Brass nuts

	Dimensions Size	Sachet de 100 pièces Bag of 100 pcs	
		d D L	
HEXAGONAUX STANDARDS STANDARD HEXAGONAL NUTS		1,4 2,2 0,8	EC-180/C

Écrous de sûreté avec bague nylon Safety nuts with nylon ring

	Dimensions Size	Sachet de 50 pièces Bag of 50 pcs	
		d D L	Blanc / White Doré / Gold
HEXAGONAUX STANDARDS STANDARD HEXAGONAL NUTS		1,2 2,25 1,5	EC-128/L EC-128/DL
		1,4 2,25 1,5	EC-130/L EC-130/DL

Écrous Nuts

EC-090 ASSORTIMENT D'ÉCROUS HEXAGONAUX
ET ÉTOILES comprenant :
SET OF HEXAGONAL AND STAR NUTS
including :

CASE	RÉFÉRENCE STOCK N°	QUANT. QUANT.
1	EC-111	100
2	EC-111/D	100
3	EC-097	100
4	EC-097/D	100
5	EC-098	100
6	EC-098/D	100
7	EC-100	100
8	EC-100/D	70
9	EC-102	1,3
10	EC-102/D	100
11	EC-103	100
12	EC-103/D	100



EC-093 ASSORTIMENT D'ÉCROUS BORGNES
HEXAGONAUX ET ÉTOILES comprenant :
SET OF HEXAGONAL AND STAR CAP NUTS
including :

CASE	RÉFÉRENCE STOCK N°	QUANT. QUANT.
1	EC-116	60
2	EC-116/D	60
3	EC-118	60
4	EC-118/D	60
5	EC-119	60
6	EC-119/D	60
7	EC-120	60
8	EC-120/D	60
9	EC-121	60
10	EC-121/D	60
11	EC-122	60
12	EC-122/D	60

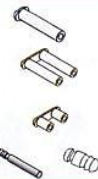

Douilles, cavaliers et fixations
type Silhouette
voir page 7 (DO-110 à DO-131
et TI-100 / TI-101)

Staple sockets and fixing
shanks Silhouette type :
see page 7 (DO-110 to DO-131
and TI-100 / TI-101)

Charnières - Rivets - Serre-cercles

Hinges, rivets and squeeze-circles

Charnières

(les assemblages de charnières sont réalisés avec des vis M 1,4)

Hinges (Assemblies of hinges are made with screws M 1.4)



CASE	RÉFÉRENCE STOCK N°	QUANT. PR
1	CH-094	5
2	CH-064	5
3	CH-097	5
4	CH-067	5
5	CH-096	5
6	CH-066	5
7	CH-092	5
8	CH-062	5
9	CH-098	5
10	CH-068	5
11	CH-093	5
12	CH-063	5

CH-108 ASSORTIMENT DE CHARNIÈRES
à souder comprenant :
SET OF SOLDER HINGES including :

* Voir tableau ci-dessus
See above board



CASE	RÉFÉRENCE STOCK N°	QUANT. PR
1	CH-052	4
2	CH-041	4
3	CH-040	4
4	CH-054	4
5	CH-058	4
6	CH-050	4
7	CH-056	4
8	CH-086	4
9	CH-085	4
10	VI-046	50
11	VI-050	50
12	RI-108	70

CH-105 ASSORTIMENT DE CHARNIÈRES
À RIVER ET À INCRUSTER comprenant :
SET OF RIVETING HINGES AND HIDDEN
HINGES including :

* Voir tableau ci-dessus
See above board

CHARNIÈRES À SOUDER (Sachet de 5 paires)
SOLDER HINGES (Bag of 5 pairs)

ASSEMBLAGE ASSEMBLY	LARGEUR TALON WIDTH OF HINGE	ÉLÉMENT BRANCHE PART OF TEMPLE	ÉLÉMENT FACE PART OF FRONT	
	0,8	2,0	CH-094/5	CH-064/5
	0,9	2,5	CH-097/5	CH-067/5
	1,2	3,0	CH-096/5	CH-066/5
	1,4	3,0	CH-092/5	CH-062/5
	1,5	3,5	CH-098/5	CH-068/5
	1,8	4,0	CH-093/5	CH-063/5

CHARNIÈRES À RIVER + CHARNIÈRES À INCRUSTER (Sachet de 5 paires)
RIVETING HINGES + HIDDEN HINGES (Bag of 5 pairs)

ASSEMBLAGE ASSEMBLY	LARGEUR TALON WIDTH OF HINGE	ÉLÉMENT BRANCHE PART OF TEMPLE		ÉLÉMENT FACE PART OF FRONT	
		A river To rivet	A river To rivet	A incruster Hidden style	
	1,0	2,5			CH-052/5
	1,2	3,0	CH-041/5	CH-040/5	CH-054/5
	1,4	4,5	CH-058/5	CH-050/5	
	1,6	3,5			CH-056/5
	0,8				
	0,9				
	0,8	4,0	CH-086/5	CH-085/5	

Rivets + rivets doubles en métal

Rivets + double rivets in metal

	QUANTITÉ QUANTITY			RÉFÉRENCE STOCK NUMBER	
	d	D	L		
	1,18	1,8	8	100	RI-108/C
	1,18	1,8	10	100	RI-110/C
	1,18	1,8	12	100	RI-112/C
	1,18	-	8,5	50	EN-116/L

Serre-cercles

(sachet de 5 paires)
Squeeze-circles
(bag of 5 pairs)

	M 1,2 - Nickel	SE-100/05
	M 1,4 - Nickel	SE-101/05



SP-098

Sphéromètre digital
Digital spherometer



AP-502

Support établi gainé
Rubberized bench block



PO-097

Pointe à tracer carbure
Pommeau aimanté
Carbide scribe
Magnetized pommel



PO-097/1

Pointe de rechange
pour PO-097
Replacement pin
for PO-097



PI-490/S

Pince pour montage Windsor
Plier for Windsor assembly



CA-200

Cache-œil noir
Black eye occluder



HI-215

Bandes sport silicone
Assortiment de 6 pièces
Silicone sport bands
Set of 6 pieces



SU-130/5

Support de nez à visser
pour montures plastique (5 paires)
Screw-on pad arm
for plastic frames (5 pairs)



SU-131/2

Support de nez à incruster (2 paires)
Pad arm to inlay (2 pairs)



FR-030/08

Fraise Mr Blue® Mr Orange®
Perçage Ø 0,8 - L. 19,0 - Tige 1,6
Mr Blue® Mr Orange® cutter
Drilling Ø 0.8 - L. 19.0 - Shank 1.6



FR-030/10

Fraise Mr Blue® Mr Orange®
Perçage Ø 1,0 - L. 19,0 - Tige 1,6
Mr Blue® Mr Orange® cutter
Drilling Ø 1.0 - L. 19.0 - Shank 1.6



FR-031/20

Fraise Mr Blue®
Perçage Ø 1,2 - L. 21,0 - Tige 2,2
Mr Blue® cutter
Drilling Ø 1.2 - L. 21.0 - Shank 2.2



FR-031/22

Fraise Mr Blue®
Perçage Ø 1,2 - L. 22,0 - Tige 2,0
Mr Blue® cutter
Drilling Ø 1.2 - L. 22.0 - Shank 2.0

LU-090

Lunettes pour la détermination des mesures face et branches

(photo 1) - La monture est réglable en largeur de face et longueur de branches.

(photo 2) - La monture permet de déterminer avec précision les dimensions en fonction de la morphologie du visage.

Frame for determination of sizes of front and temples

(photograph 1) - The frame is adjustable in front width and temple length.

(photograph 2) - The frame allows to determine sizes with precision according to the morphology of the face.



LO-180/125

LO-180/150

LO-180/175

LO-180/200

LO-180/250

LO-180/300

Lentilles de vision de près

autostatiques, adaptables sur de nombreux types de lunettes
(par exemple : lunettes de protection, de soleil, de plongée...)

Supplementary lenses for near vision

*autostatic, adaptable on many types of glasses
(for example : protective glasses, sunglasses, diving goggles...)*



PL-194/5

Plaquettes autocollantes silicone
15 mm, épaisseur 1 mm

*Stick-on silicone nose pads
15 mm, 1 mm thick*



LU-232

Lunettes de protection
polycarbonate jaune. Branches réglables

*Protective glasses
yellow polycarbonate. Adjustable temples*

Lunettes loupes, protection contre la lumière bleue. Bloquent 25 à 30 % de la lumière bleue nocive.
Magnifying glasses, protection against blue light. Block 25 to 30 % of the harmful blue light



- LU-400/10** Écaille foncé + 1,0 / Dark tortoise + 1.0
- LU-400/15** Écaille foncé + 1,5 / Dark tortoise + 1.5
- LU-400/20** Écaille foncé + 2,0 / Dark tortoise + 2.0
- LU-400/25** Écaille foncé + 2,5 / Dark tortoise + 2.5
- LU-400/30** Écaille foncé + 3,0 / Dark tortoise + 3.0



- LU-401/10** Gris + 1,0 / Grey + 1.0
- LU-401/15** Gris + 1,5 / Grey + 1.5
- LU-401/20** Gris + 2,0 / Grey + 2.0
- LU-401/25** Gris + 2,5 / Grey + 2.5
- LU-401/30** Gris + 3,0 / Grey + 3.0



- LU-402/10** Bleu + 1,0 / Blue + 1.0
- LU-402/15** Bleu + 1,5 / Blue + 1.5
- LU-402/20** Bleu + 2,0 / Blue + 2.0
- LU-402/25** Bleu + 2,5 / Blue + 2.5
- LU-402/30** Bleu + 3,0 / Blue + 3.0

FA-230/B1

Face relevable, protection contre la lumière bleue.
S'adapte sur les lunettes de vue.

Flip-up clip, protection against blue light.
Fits on prescription glasses.



Faces solaires, mécanisme mini. Boîte de 12 pièces.
Sun clips, with mini mechanism. Box of 12 pieces.

FA-310/12

Petit modèle, gris / *Small size, grey*



FA-311/12

Petit modèle, marron / *Small size, brown*



FA-320/12

Moyen, gris / *Medium size, grey*

FA-321/12

Moyen, marron / *Medium size, brown*



FA-330/12

Grand modèle, gris / *Large size, grey*

FA-331/12

Grand modèle, marron / *Large size, brown*

TE-250

Testeur de diamètre.

Permet de réaliser toutes les mesures des diamètres utiles avec un seul tracé figuratif.

Diameter tester.

Allows to carry out all measures of useful diameters with only one figurative drawing.

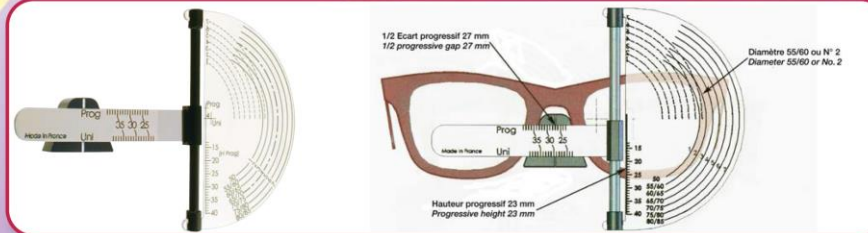

FR-032/10

Fraise Briot®, hélice gauche
Briot® cutter, left helix



FR-033/10

Fraise Briot®, hélice droite
Briot® cutter, right helix



FR-034/10

Fraise Nidek®, hélice droite
Nidek® cutter, right helix

EM-264

Gaine rétractable à plat, 13 mm
Flat heat shrink temple sleeve, 13 mm



DI-102

Dispositif de montage des fils nylon

Pour une insertion facile et rapide du fil à drageoir en 8.
Convient pour les fils allant de 0.45 à 0.55 mm.

Device for nylon cord mounting

For an easy and fast introduction of cord in figure 8.
Suitable for cords from 0.45 to 0.55 mm.

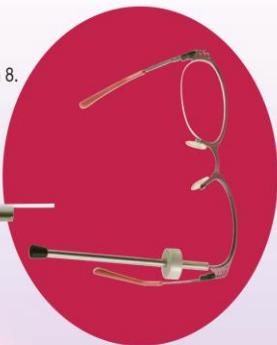

CH-054/5

Charnières à incruster

assemblage 1.2
(sachet de 5 paires)

Hidden hinges

Assembly 1.2
(bag of 5 pairs)



AN-201/5

Fil à drageoir silicone en anneaux

(sachet de 5 paires)

Silicone cord in ring

(bag of 5 pairs)



PI-154/S

Pince à courber les branches

Plier for bending temples

CO-650

Cordons silicone enfants

6 pièces de couleurs assorties

Silicone cords for children

6 pieces of assorted colours



PI-138/S

Pince à régler les supports de plaquettes

Plier for setting nose pad arms



EC-303

Echelle pour enfants,

lecture à 5 mètres

Sight test for children,

reading at 5 meters

EC-306

Echelle de Parinaud,

pour illettrés

Parinaud sight test,

for illiterates



Lunettes de protection contre la lumière bleue
Protective glasses against blue light.



LU-439

Modèle teenagers. Face bleue,
branches noires
Model for teenagers. Blue front,
black temples



LU-438

Modèle enfants. Face rouge,
branches noires
Model for children. Red front,
black temples



LU-450

Modèle adultes. Noir
Model for adults. Black



PR-110

Présentoir bois,
5 lunettes
*Wooden display,
for 5 glasses*



TO-195

Tournevis Torx T3
Torx T3 screwdriver

VI-601/25

Vis Torx T3
1.4 x 2 x 3.5
*Torx T3 screws
1.4 x 2 x 3.5*



VE-183/5

Bloc Nidek, verres forte base
(sachet de 5 pièces)
*Nidek blocks for lenses with high base
(bag of 5 pieces)*



SO-400

Solvant 1 L
Efface tous types de marquages
*Solvent 1 L
Erases any type of marking*



RU-200

Ruban de mesure du périmètre crânien
Skull perimeter measuring tape

VE-202

Ventouse fond de lavabo
Permet la récupération facile
des lentilles de contact
*Washbasin suction-grip mat
Allows to recover
contact lenses easily*

